

Owner's Manual

Air to Water Heat Pumps

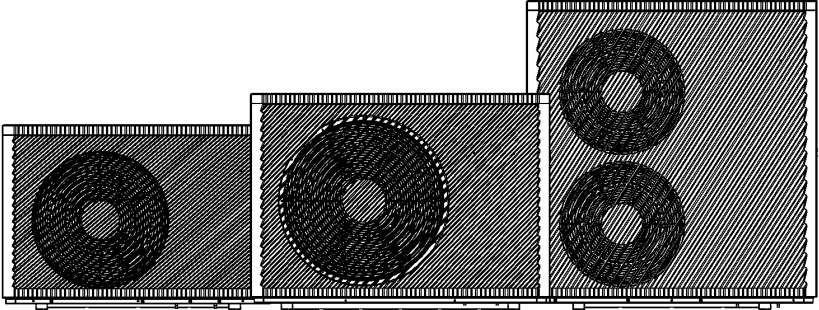

CH-HP09UIMPZK CH-HP15UIMPZM CH-HP22UIMPZM

Content

1. Preface	1
2. Safety Instructions	2
3. Features	5
4. Unit Dimension	6
5. Installation Diagram	7
6. Handling & Installation	9
7. Maintenance	16
8. Parameters	19
9. Operation Range	21
10. Explosion View	31
11. Wiring Diagram	35
12. Display Operation Guide	40
13. Electrical Parameter	53
14. Failure List & Troubleshooting	59
15. MODBUS RTU PROTOCOL	64

1. Preface

In order to provide the customers with high quality, strong reliability and good versatility products, this heat pump is produced by strict design and manufacture standards. This manual includes all the necessary information about installation, debugging, discharging and maintenance. Please read this manual carefully before you open or maintain the unit.

The manufacture of this product will not be held responsible if someone is injured or the unit is damaged, as a result of improper installation, debugging, unnecessary maintenance which is not in line with this manual.

The unit must be installed by qualified personnel.

It is vital that the below instructions are adhered to at all times to keep the warranty.

- The unit can only be opened or repaired by a qualified installer or an authorized dealer.
- Maintenance and operation must be carried out according to the recommended time and frequency, as stated in this manual.
- Use genuine standard spare parts only.

Failure to comply with these recommendations will invalidate the warranty.



Inverter air source water heat pump is a kind of high efficiency, energy saving and environment friendly equipment, which is mainly used for house warming. It can work with any kinds of indoor unit such as fan coil, radiator, or floor heating pipe, by providing warm or hot water. One unit of monoblock heat pump can also work with several indoor units.

The air source water heat pump unit is designed to have heat recovery by using super heater which can provide hot water for sanitary purpose.



2. Safety Instructions

To prevent the users and maintainers from the harm of this unit, and avoid damage to the unit or other property, and use the heat pump properly, please read this manual carefully and understand the following information correctly.



Mark Notes



Mark	Meaning
 WARNING	A wrong operation may lead to death or grievous injury on people.
 ATTENTION	A wrong operation may lead to harm to people or loss of material.



Icon Notes



Icon	Meaning
	Prohibition. What is prohibited will be nearby this icon.
	Compulsory implement. The listed action needed to be taken.
	ATTENTION (include WARNING) Please pay attention to what is indicated.

Warning



Operation	Meaning
 Prohibition	DO NOT put fingers or others into the fan and evaporator of the unit, otherwise harm may occur.
 Shut off the power.	When there is something wrong or strange smells, the power supply needs to be shut off to stop the unit. Continue running may cause short circuit or fire.

Operation	Meaning
 Prohibition	DO NOT put fingers or others into the fan and evaporator of the unit, otherwise harm may occur.
 Shut off the power.	When there is something wrong or strange smells, the power supply needs to be shut off to stop the unit. Continue running may cause short circuit or fire.



Move and Repair	Meaning
 Entrust	When the heat pump needs to be moved or installed again, please entrust dealers or qualified people to carry it out. Improper installation will lead to water leakage, electrical shock, injury or fire.
 Entrust	It is prohibited from repair the unit by the user himself, otherwise electrical shock or fire may occur.
 Prohibit	When the heat pump needs to be repaired, please entrust dealers or qualified people to carry it out. Improper movement or repair on the unit will lead to water leakage, electrical shock, injury or fire.

	<p>Do not use means to accelerate the defrosting process or to clean, other than those recommended by the manufacturer.</p>
	<p>The appliance shall be stored in a room and installed in the environment without continuously operating or potential ignition sources (for example: open flames, an operating gas appliance or an operating electric heater or Electric Spark or hot objects).</p>

ATTENTION

Installation	Meaning
 Installation Place	<p>The unit CANNOT be installed near the flammable gas. Once there is any leakage of the gas, fire may occur.</p>
 Fix the unit.	<p>Make sure that the basement of the heat pump is strong enough, to avoid any decline or fall down of the unit</p>
 Need circuit breaker.	<p>Make sure that there is circuit breaker for the unit, lack of circuit breaker may lead to electrical shock or fire.</p>

Operation	Meaning
 Check the installation basement.	<p>Please check the installation basement regularly (once a month), to avoid any decline or damage to the basement, which may hurt people or damage the unit.</p>

 Switch off the power.	Please switch off the power when cleaning or maintaining.
 Prohibition	It is prohibited from using copper or iron as fuse. The right fuse must be fixed by electricians for the heat pump.
 Prohibition	It is prohibited from spray the flammable gas to the heat pump, as it may cause fire.

3. Features

This series of heat pump unit owns following features:

3.1. Advanced Controlling

The PC micro-computer based controller is available for the users to review or set the running parameters of the heat pump. Centralized controlling system can control several units by PC.

3.2. Nice Appearance

The heat pump is designed with beautiful looking. The monoblock one has the water pump included which is very easy for installation.

3.3. Flexible Installation

The unit has a smart structure with compact body, just as simple outdoor installation is needed.

3.4. Quiet Running

The heat pump unit use a special designed heat exchanger to enhance whole efficiency.

3.5. Good Heat Exchange Rate

The heat pump unit use a special designed heat exchanger to enhance whole efficiency.

3.6. Large Working Range

This series of heat pump is designed to work under different working conditions as low as -15 degrees for heating.

4. Unit Dimension(mm)

4.1. Models: CH-HP09UIMPZK

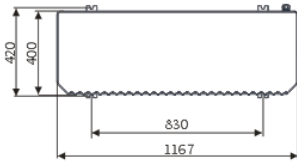
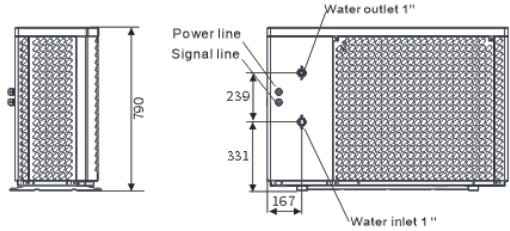
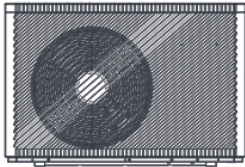

4.2. Models: CH-HP15UIMPZM

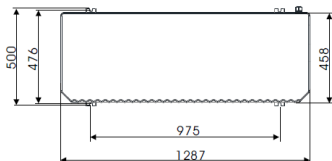
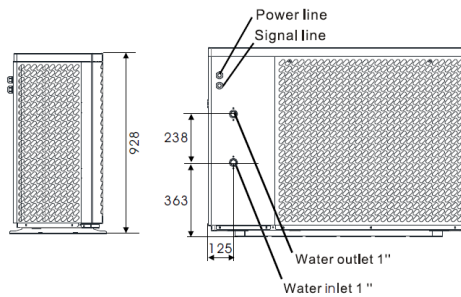
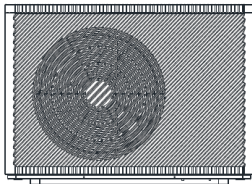

4.3. Models: CH-HP22UIMPZM

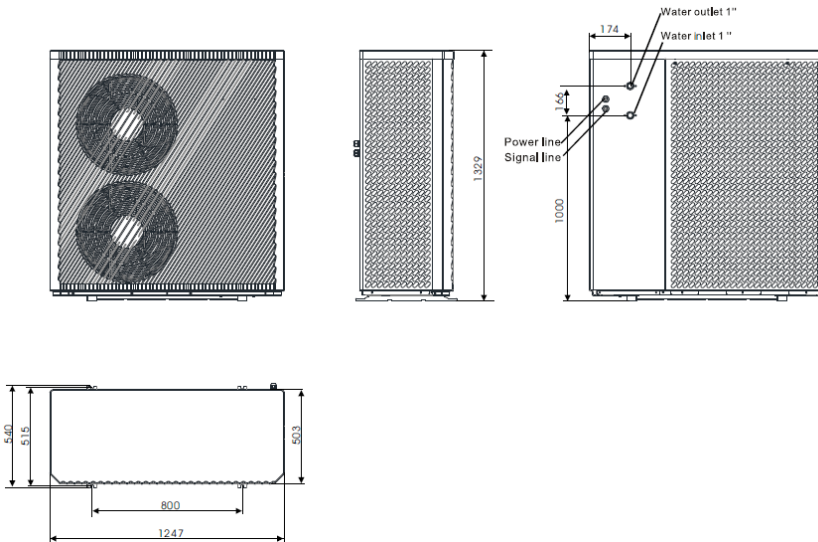

5. Installation Diagram

C&H monoblock heat pumps can provide heating/cooling and domestic hot water. Floor heating loops and fan coil units are used for space heating and fan coil units are used for space cooling. Domestic hot water is supplied from the domestic hot water tank connected to the heat pump.

5.1 Traditional Installation

C&H provides the monoblock heat pump with a main circulation pump built inside. When install the unit, installers should connect the heat pump with other parts including the buffer tank (for space heating/cooling), storage water tank (for domestic hot water) and water pumps (for space heating/cooling water circulation and domestic hot water). External fittings are also needed including a safety valve, a water charge valve, hot water valves (three-way valve). Temperature sensor should be added in the storage water tank. An additional electric heater can be installed in the DHW tank or the buffer tank which can get the control signal from the heat pump.

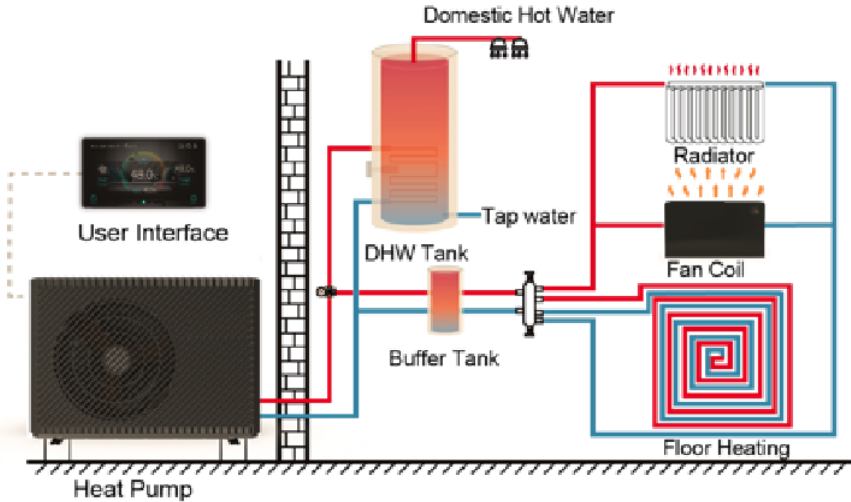

5.2 Installation with Hydronic Module

C&H provides the monoblock heat pump (without circulation pump) and the Hydronic box. Hydronic box includes one small size built-in buffer tank, one main circulation water pump, one space heating/cooling circulation water pump, one DHW pump, a safety valve, a water charge valve and an expansion tank, electrical heater. When installing the unit, installers should connect the heat pump directly to the Hydronic box while the buffer tank (for space heating/cooling) is considered whether to be added or not. Storage water tank is needed for the domestic hot water application. Temperature sensor should be added in the storage water tank.

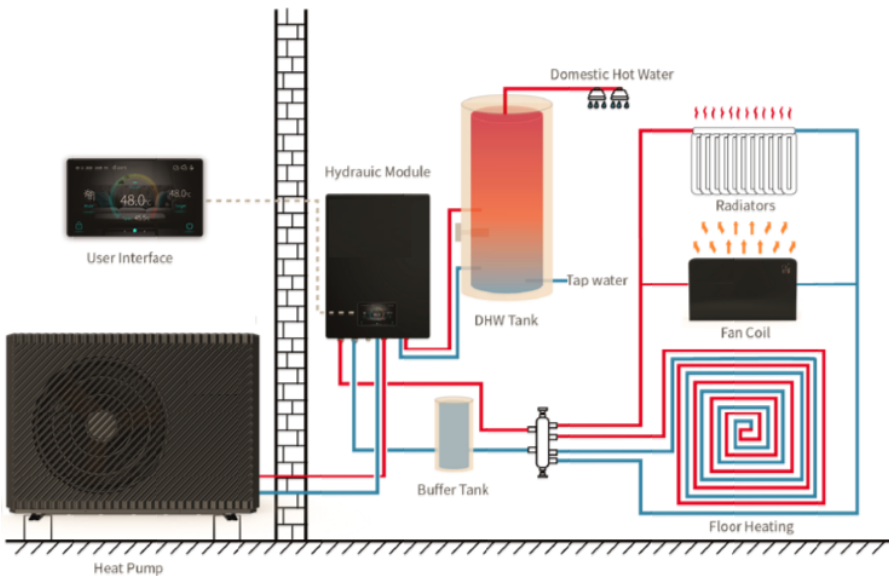

5.3 Installation with Multi-functions Tank

C&H provides the monoblock heat pump and the Multi-functions tank. A multi-functions tank includes one buffer tank, one storage tank, one main circulation water pump, one space heating/cooling circulation water pump, one domestic hot water pump, a safety valve, a water charge valve and hot water valve. When installing the unit, installers just connect the heat pump directly to the multi-functions tank.

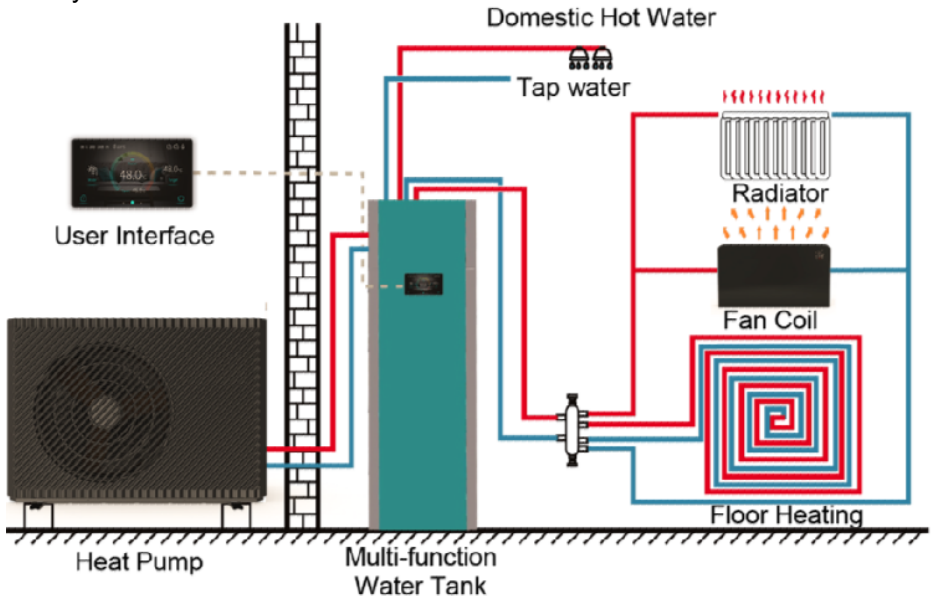

6. Handling & Installation

Unit features

a. Plate heat exchanger

Use the SWEP efficient heat exchanger with small size and high efficiency.

b. Environmentally friendly refrigerant

Use the new generation of environmentally friendly refrigerant R290, which is harmless to the ozone sphere.

c. Heating in frigid environment.

Optimized designed unit can achieve the heating function normally even when the ambient temperature is -25°C .

d. Infusing refrigerant

The Heat Pump is full of refrigerant when Ex-factory.

e. Installation Environment

The refrigerant R290 are flammable and explosive, It's prohibited from

installing in one environment which have operating or potential ignition sources.

6.1. Application of Heat Pump

6.1.1. House Heating/Cooling + Domestic Hot Water

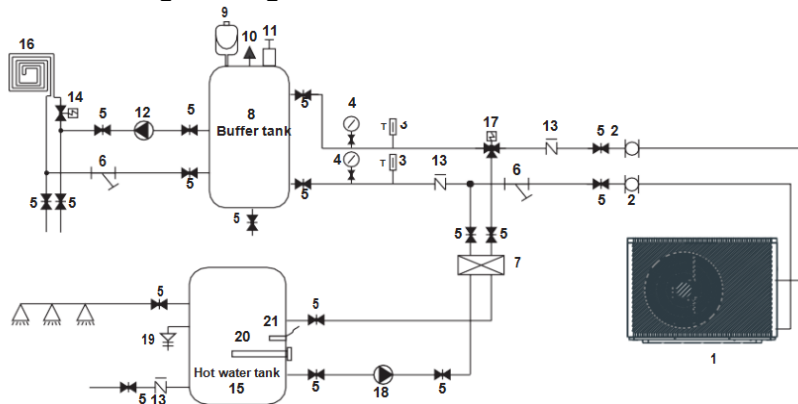

1	Heat pump	10	Relief valve	19	PT valve
2	Flexible pipe	11	Air vent valve	20	Electrical heater
3	Thermometer	12	Water pump for floor heating	21	Hot water sensor
4	Manometer	13	Check valve		
5	Shut-off valve	14	Floor heating valve		
6	Y type water filter	15	Hot water tank		
7	Plate heat exchanger	16	Floor heating pipe/fan coil unit		
8	Buffer tank	17	Hot water valve		
9	Expansion tank	18	Hot water pump		

Remark: Item 17, 18, 20, 21 can be connected with heat pump.

6.1.2. House Heating/Cooling (including Buffer tank)

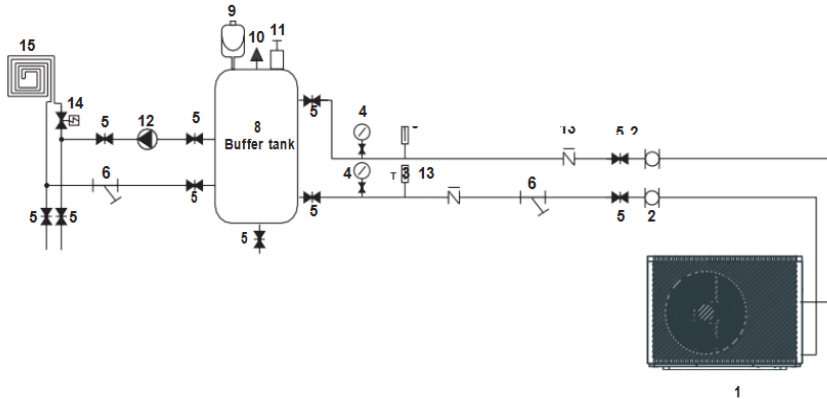

1	Heat pump	7	Plate heat exchanger	13	Check valve
2	Flexible pipe	8	Buffer tank	14	Floor heating valve
3	Thermometer	9	Expansion tank	15	Floor heating pipe/fan coil unit
4	Manometer	10	Relief valve		
5	Shut-off valve	11	Air vent valve		
6	Y type water filter	12	Water pump for floor heating		

6.2. Choose a right heat pump unit

- (1) Based on the local climate condition, construction features and insulation level, calculate the required cooling(heating) capacity per square meter.
- (2) Conclude the total capacity which will be needed by the construction.
- (3) According to the total capacity needed, choose the right model by consulting the heat.
- (4) Pump features as below:
 - a. Cooling only unit: chilled water outlet temp. at 5-15°C, maximum ambient temp. at 43°C.
 - b. Heating and Cooling unit: for cooling chilled water outlet temp. at 5-15°C, maximum ambient temp. at 43°C. For heating, warm water outlet temp. at 9-75°C, minimum ambient temp. at -25°C.
 - c. Unit application
Inverter air source water heat pump is used for house, office, hotel, and so forth, which need heating or cooling separately, with each area needed to be controlled.

6.3. Installation Method

The heat pump can be installed onto the concrete basement by expansion screws, or onto a steel frame with rubber feet which can be placed on the ground or housetop.

Make sure that the unit is placed horizontally.

6.4. Installation Place

- a. The unit can be installed on any place outdoor which can carry heavy machine such as terrace, housetop, ground and so on.
- b. The location must have good ventilation.
- c. The place is free from heat radiation and other fire flame.
- d. A pall is needed in winter to protect the heat pump from snow.
- e. There must be not obstacles near the air inlet and outlet of the heat pump. A place which is free from strong air blowing.
- f. There must be water channel around the heat pump to drain the condensing water. There must be enough space around the unit for maintenance.
- g. A place which is far away operating or potential ignition sources (for example: open flames, an operating gas appliance or an operating electric heater or Electric Spark or hot object)

6.5. Refrigerant charge

The heat pump is not infused with the refrigerant 290 and full of high-pressure nitrogen or keep it in a vacuum instead, please follow these steps to infusing refrigerant R290.

1. Preparations

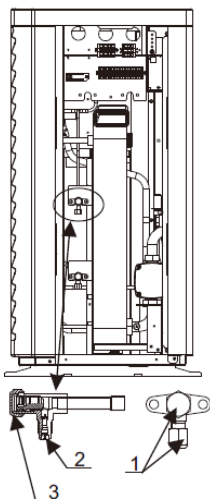

Stop valve signs:
Low pressure

- a. Please in a well-ventilated environment while charge refrigerant.
 - b. Keep away from open flames or potential sources of fire.
 - c. Disconnect the power supply of the heat pump.
 - d. Carefully check the nameplate of the heat pump and charge strictly according to the labeled amount.
2. Check the pressure of nitrogen gas inside the system. The heat pump has charged about 30 Bar pressure nitrogen gas inside the system, please check whether there is still high-pressure nitrogen before charging refrigerant, otherwise check the leakage point. (Use spanner remove the seal nut 1 and 3, use 5mm inner hexagon spanner open the valve 2. If it can Blowing out the high-pressure gas then the heat pump is not leaking.)
3. Use 5mm inner hexagon spanner open the valve 2 and release all the nitrogen gas inside the system.

4. Vacuumize the heat pump. Connect the vacuum pump with the valve 2, keep vacuum pump running until the absolute pressure below 30Pa or operating time more than one hour.

5. Charge refrigerant. Keep the refrigerant in liquid state when charging and strictly according to the labeled amount.
6. Finish the charging, close the valve 2 and screw the seal nut 1 and 3.

6.6. Water Loop Connection

Please pay attention to below matters when the water pipe is connected:

- (1) Try to reduce the resistance to the water from the piping.
- (2) The piping must be clear and free from dirty and blocks. Water leakage test must be carried out to ensure there is no water leaking. And then the insulation can be made.
- (3) Attention that the pipe must be tested by pressure separately. DO NOT test it together with the heat pump.
- (4) There must be expansion tank on the top point of the water loop, and the water level in the tank must be at least 0.5 meter higher than the top point of the water loop.
- (5) The flow switch is installed inside of the heat pump, check to ensure that the wiring and action of the switch is normal and controlled by the controller.
- (6) Try to avoid air stayed inside of the water pipe, and there must be air vent on the top point of the water loop.
- (7) There must be thermometer and pressure meter at the water inlet and outlet, for easy inspection during running.

6.7. Power Supply Connection

- (1) Open the front panel, and open the power supply access.
- (2) The power supply must go through the wire access and be connected to the power supply terminals in the controlling box. Then connect the 3-signal wire plugs of the wire controller and main controller.
- (3) If the outside water pump is needed, please insert the power supply wire into the wire access also and connect to the water pump terminals.
- (4) If an additional auxiliary heater is need to be controlled by the heat pump controller, the relay (or power) of the aux-heater must be connected to the relevant output of the controller.

6.8. Location of the Unit

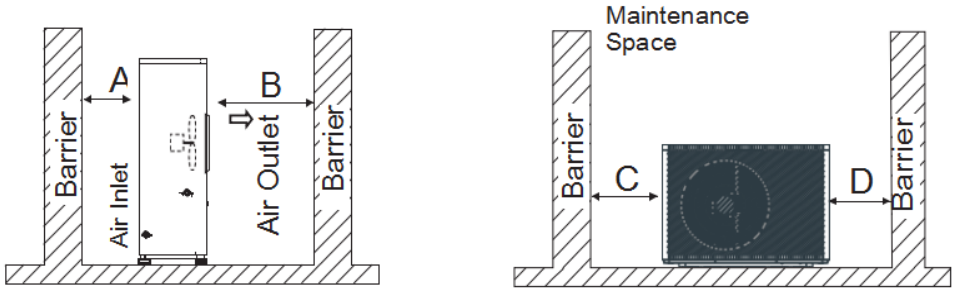

The picture shows the location of horizontal air outlet unit.



Attention

Requirements:

A>500mm ; B>1500mm ;
C>1000mm ; D>500mm

6.9. Transit

When the unit needs to be hung up during installation, an 8 meters cable is needed, and there must be soft material between the cable and the unit to prevent damage to the heat pump cabinet. (See picture 1)

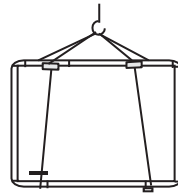

Picture 1



WARNING

DO NOT touch the heat exchanger of the heat pump with fingers or other objects!

6.10. Trial Running

6.10.1. Inspection before trial running

- (1) Check the indoor unit, and make sure that the pipe connection is right and the relevant valves are open.
- (2) Check the water loop, to ensure that the water inside of the expansion tank is enough, the water supply is good, the water loop is full of water

and without any air. Also make sure there is good insulation for the water pipe.

- (3) Check the electrical wiring. Make sure that the power voltage is normal, the screws are fastened, the wiring is made in line with the diagram, and the earthing is connected.
- (4) Check the heat pump unit including all of the screws and parts of the heat pump to see if they are in good order. When the power is on, review the indicator on the controller to see if there is any failure indication. The gas gauge can be connected to the check valves to see the high pressure (or low pressure) of the system during trial running.

6.10.2. Trial running

- (1) Start the heat pump by press "  " key on the controller. Check whether the water pump is running, if it runs normally there will be 0.2 MPa on the water pressure meter.
- (2) When the water pump runs for 1 minutes, the compressor will start. Hear whether there is strange sound from the compressor. If abnormal sound occurs please stop the unit and check the compressor. If the compressor runs well please look for the pressure meter of the refrigerant.
- (3) Then check whether the power input and running current is in line with the manual. If not please stop and check.
- (4) Adjust the valves on the water loop, to make sure that the hot(cool) water supply to each door is good and meet the requirement of heating (or cooling). Review whether the outlet water temperature is stable.
- (5) The parameters of the controller are set by the factory, it is not allowed to change then by the user himself.

If the water flow rate is lower than 70% of the rated water flow, the defrosting efficiency will be lower. The suggested water flow rate shall be the rated flow rate which is shown on the nameplate.

7. Maintenance

7.1. Precautions for Daily Use

Before starting up the unit for the first time or after a long-time shutdown, the following preparations must be made:

- (1) Thoroughly inspect and clean up the unit.
- (2) Clean the waterway system.
- (3) Check water pump, regulating valve and other waterway equipment.
- (4) Tighten all wire connections.

Do not change the system parameters before consulting the engineer.

Ensure the water refill and exhaust device in the waterway is well, otherwise the performance and reliability of the unit will become worse.

Ensure the waterways are clean and avoid dirt and blockage.

Timely check the electricity, water and replace the faulty parts.

Please use the parts provided or recommended by the company, do not use the unqualified parts.

Refrigerant supplement:

Each unit has been equipped with sufficient refrigerant when leaving the factory. Do not charge or change the refrigerant.

If you need to replenish the refrigerant due to leakage, please contact the engineers or dealers.

7.2. Periodic Maintenance (every 6 months)

Preparation	Before maintenance, please ensure that the unit stop running and cut off the power supply.
Inspection and cleaning of fin heat exchanger	In order to ensure that heat exchangers remain in optimum condition for heat exchange, their surfaces must be clean.
Inspection and cleaning of plate heat exchanger	Every 6 months or when the capacity of the unit drops by more than 10%, check the water-side heat exchanger for scale and clean the heat exchanger.
Check the electrical wiring	Check if the contact point is loose, oxidized, or blocked by sundries, etc., which causes poor contact of the electronic wiring.

7.3. Inspection and Maintenance

7.3.1. Preparing for inspection and maintenance

Danger!

Risk of death caused by fire or explosion if there is a refrigerant leakage!

Only carry out the work if you are competent and have knowledge about the special features and risks of R290 refrigerant.

The product contains combustible refrigerant R290. In the event of a leak, escaping refrigerant may mix with air to form a flammable atmosphere. There is a risk of fire and explosion.

Ensure that space is sufficiently aerated around the product.

Observe the basic safety rules before carrying out inspection and maintenance work or installing spare parts.

Disconnect the product from the power supply but ensure that the product is still earthed.

7.3.2. Cleaning the product

Do not clean the product with a high-pressure cleaner or a direct jet of water.

Clean the product using a sponge and hot water with a cleaning agent.

Do not use abrasive cleaners. Do not use solvents. Do not use any cleaning agents that contain chlorine or ammonia.

7.3.3. Checking the evaporator, fan, and condensate discharge

Check whether there is dirt between the fins or whether depositions have adhered to the fins.

Clean the fins using a soft brush, avoid fins from being bent.

Check whether dirt has been accumulated on the condensate tray or in the condensate discharge pipe.

Check whether the water can drain freely.

8. Parameters

Model		CH-HP09UIMPZK	CH-HP15UIMPZM	CH-HP22UIMPZM
Power Supply	/	230V~/50Hz	380~415V/3N~/50Hz	380~415V/3N~/50Hz
Moisture Resistance	IPX	IPX4	IPX4	IPX4
Electrical Shockproof	I	I	I	I
Heating Condition - Ambient Temp. (DB/WB): 7/6°C, Water Temp. (In/Out): 30/35°C				
Heating Capacity Range	kW	3.10~8.90	5.40~14.95	8.00~22.00
Heating Power Input Range	kW	0.65~2.10	1.05~3.85	1.60~6.90
Heating Current Input Range	A	2.9~9.2	1.9~6.8	2.8~12.2
Cooling Condition - Ambient Temp. (DB/WB): 35/24°C, Water Temp. (In/Out): 12/7°C				
Cooling Capacity Range	kW	1.20~5.72	3.60~10.50	4.20~15.00
Cooling Power Input Range	kW	0.65~2.40	1.12~4.47	1.80~7.30
Heating Current Input Range	A	2.9~10.5	2.0~7.9	3.2~12.9
Hot Water Condition - Ambient Temp. (DB/WB): 20/15°C, Water Temp. (In/Out): 15/55°C				
Hot Water Capacity Range	kW	3.92~10.68	6.50~18.50	10.00~27.00
Hot Water Power Input Range	kW	0.78~2.47	1.27~4.65	1.90~7.10
Hot Water Current Input Range	A	3.4~10.8	2.4~8.21	3.4~12.5
Max. Power Input	kW	3.0	5.3	9
Max. Current Input	A	13.5	10.5	15.8
Water Flow	m ³ /h	1.0	1.7	2.9
Refrigerant / Proper Input	kg	R290 /0.50kg	R290 / 0.85kg	R290 / 1.30kg
CO ₂ Equivalent	Ton	0.0015	0.0026	0.0039
Sound Pressure (1m)	dB(A)	42		47
Sound Power Level (EN12102)	dB	57	58	62
Net Weight	kg	80	160	202
Operation Pressure(Low Side)	MPa	0.8	0.8	0.8
Operation Pressure(High Side)	MPa	3.0	3.0	3.0
Unit Dimension(L/W/H)	mm	1167×407×795	1287×458×928	1250×540×1330
Shipping	mm	1300×485×940	1420×540×1080	1380×570×1480

Compressor	Brand	HIGHLY	HIGHLY	HIGHLY
Circulation Pump	Brand	GRUNDFOS	GRUNDFOS	GRUNDFOS
Operating Ambient Temperature	°C	-25~43	-25~43	-25~43
Fan Quantity	/	1	1	2
Fan Motor Type	/	DC motor	DC motor	DC motor
Fan Motor Power Input (min~max)	W	55~105	60~120	60~160
Fan Speed (RPM)	RPM	300~600	220~600	300~750
Water Connection (inch)	inch	1	1	1
Water Pressure Drop (max)	kPa	40	20	65
Circulation Pump Head	m	7.5	7.5	12.5
Cabinet Type		Galvanized sheet+ ASA	Galvanized sheet+ ASA	Galvanized sheet+ ASA

9. Operation Range
9.1 CH-HP09UIMPZK

Performance Curve																				
CH-HP09UIMPZK																				
Heating Capacity(kW)																				
				90Hz		84Hz		78Hz		72Hz		66Hz		60Hz		54Hz		48Hz		
Water outlet(°C)	-30	-25	-20	-16	-15	-12	-7	-5	0	1	2	5	7	10	14	15	20	25	30	35
35	/	3.60	4.36	5.01	5.19	6.13	7.18	7.64	8.23	8.29	8.54	8.78	8.90	9.45	9.34	9.49	10.31	10.54	10.26	11.19
41	/	3.51	4.23	4.87	5.04	5.30	6.22	6.59	7.40	7.47	7.69	7.90	8.01	8.56	8.57	8.70	9.45	9.49	10.27	10.69
45	/	3.43	4.14	4.76	4.93	5.18	6.05	6.44	7.24	7.30	7.52	7.72	7.83	8.32	8.26	8.38	9.16	9.27	10.10	10.51
50	/	3.35	4.02	4.62	4.78	5.03	5.87	6.25	7.03	7.09	7.30	7.49	7.60	8.06	7.36	7.47	8.12	8.98	9.79	10.22
55	/	3.22	3.89	4.48	4.63	4.52	5.27	5.61	6.28	6.33	6.52	6.69	6.78	7.25	7.09	7.19	7.81	7.81	8.94	9.98
60	/	3.17	3.75	4.29	4.44	4.01	4.69	5.00	6.05	6.10	6.28	6.44	6.54	6.92	6.75	6.85	7.66	7.51	8.61	9.82
65	/	/	3.36	3.85	3.98	3.85	4.50	4.80	5.17	5.21	5.37	5.67	5.75	6.09	6.17	6.26	6.80	6.39	7.33	6.98
70	/	/	/	3.67	3.79	3.67	4.29	4.54	4.93	4.97	5.12	5.40	5.48	5.79	5.88	5.96	6.47	6.08	6.97	6.64
75	/	/	/	/	/	/	4.06	4.30	4.45	4.64	4.79	5.11	5.24	5.46	5.54	5.62	6.10	/	/	/
Power Input(kW)																				
Water outlet(°C)	-30	-25	-20	-16	-15	-12	-7	-5	0	1	2	5	7	10	14	15	20	25	30	35
35	/	1.71	1.75	1.77	1.77	1.83	1.87	1.89	1.92	1.94	1.95	1.96	1.98	2.00	1.77	1.78	1.79	1.74	1.38	1.42
41	/	1.81	1.86	2.00	2.06	2.06	2.12	2.14	2.04	2.04	2.06	2.06	2.07	2.07	1.82	1.83	1.85	1.70	1.46	1.49
45	/	1.87	1.93	2.08	2.15	2.15	2.17	2.19	2.22	2.17	2.17	2.02	2.05	2.09	1.95	1.96	1.93	1.78	1.60	1.61
50	/	1.93	1.98	2.14	2.20	2.22	2.27	2.28	2.31	2.26	2.27	2.15	2.15	2.20	2.05	2.05	2.05	1.90	1.72	1.73
55	/	1.97	2.04	2.21	2.28	2.12	2.15	2.18	2.19	2.19	2.19	2.21	2.23	2.24	1.95	1.97	1.98	1.76	1.81	1.83
60	/	2.35	2.39	2.41	2.45	2.25	2.27	2.32	2.36	2.37	2.38	2.39	2.39	2.40	2.09	2.09	2.10	2.09	1.95	1.97
65	/	/	2.55	2.59	2.62	2.54	2.63	2.70	2.55	2.50	2.51	2.48	2.47	2.54	2.35	2.36	2.37	2.18	2.25	2.25
70	/	/	/	2.71	2.78	2.87	2.93	3.03	2.87	2.82	2.84	2.79	2.80	2.88	2.66	2.67	2.70	2.48	2.39	2.41
75	/	/	/	/	/	/	3.10	3.06	2.80	2.83	2.84	2.87	2.88	2.93	2.85	2.87	2.88	/	/	/

COP																				
Water outlet(°C)	-30	-25	-20	-16	-15	-12	-7	-5	0	1	2	5	7	10	14	15	20	25	30	35
35	/	2.11	2.49	2.84	2.94	3.34	3.84	4.05	4.28	4.27	4.37	4.48	4.49	4.74	5.27	5.34	5.75	6.05	7.43	7.88
41	/	1.94	2.28	2.44	2.45	2.58	2.94	3.08	3.63	3.65	3.74	3.83	3.87	4.12	4.72	4.75	5.12	5.60	7.01	7.20
45	/	1.83	2.15	2.29	2.29	2.40	2.79	2.94	3.26	3.36	3.46	3.82	3.82	3.98	4.22	4.28	4.74	5.22	6.32	6.52
50	/	1.74	2.03	2.16	2.17	2.27	2.58	2.74	3.04	3.13	3.22	3.49	3.54	3.67	3.60	3.64	3.96	4.73	5.69	5.92
55	/	1.63	1.90	2.03	2.03	2.14	2.46	2.57	2.87	2.88	2.97	3.02	3.04	3.24	3.64	3.66	3.93	4.45	4.93	5.46
60	/	1.35	1.57	1.78	1.81	1.78	2.06	2.15	2.57	2.58	2.64	2.70	2.73	2.89	3.24	3.27	3.65	3.59	4.41	4.98
65	/	/	1.32	1.49	1.52	1.51	1.71	1.77	2.03	2.08	2.14	2.29	2.33	2.40	2.63	2.65	2.86	2.93	3.26	3.10
70	/	/	/	1.35	1.36	1.28	1.46	1.50	1.72	1.76	1.80	1.93	1.96	2.02	2.21	2.23	2.40	2.45	2.92	2.76
75	/	/	/	/	/	/	1.31	1.41	1.59	1.64	1.69	1.78	1.82	1.86	1.94	1.96	2.12	/	/	/

COP																				
Water outlet(°C)	-30	-25	-20	-16	-15	-12	-7	-5	0	1	2	5	7	10	14	15	20	25	30	35
35	/	2.13	2.52	2.86	2.97	3.38	3.88	4.09	4.32	4.31	4.41	4.52	4.54	4.78	5.32	5.40	5.80	6.11	7.51	7.96
41	/	1.96	2.30	2.46	2.47	2.60	2.97	3.11	3.67	3.69	3.78	3.87	3.91	4.17	4.76	4.80	5.17	5.65	7.08	7.27
45	/	1.85	2.17	2.31	2.31	2.43	2.82	2.97	3.30	3.40	3.50	3.86	3.86	4.02	4.27	4.32	4.79	5.27	6.38	6.59
50	/	1.76	2.05	2.18	2.19	2.29	2.61	2.76	3.07	3.16	3.25	3.52	3.58	3.71	3.63	3.68	3.99	4.77	5.75	5.98
55	/	1.65	1.92	2.05	2.06	2.16	2.48	2.60	2.90	2.91	3.00	3.05	3.07	3.27	3.68	3.69	3.97	4.49	4.98	5.52
60	/	1.36	1.59	1.80	1.83	1.80	2.09	2.17	2.59	2.60	2.67	2.73	2.76	2.92	3.27	3.30	3.68	3.63	4.45	5.03
65	/	/	1.33	1.50	1.53	1.53	1.73	1.79	2.05	2.11	2.16	2.31	2.35	2.42	2.65	2.68	2.89	2.96	3.29	3.13
70	/	/	/	1.37	1.38	1.29	1.48	1.51	1.73	1.78	1.82	1.95	1.98	2.04	2.23	2.25	2.42	2.47	2.95	2.79
75	/	/	/	/	/	/	1.32	1.42	1.61	1.66	1.71	1.80	1.84	1.88	1.96	1.98	2.14	/	/	/

9.3 CH-HP15UIMPZM

Performance Curve																																			
CH-HP15UIMPZM																																			
Heating Capacity(kW)																																			
				90Hz				84Hz				78Hz				72Hz				66Hz				60Hz				54Hz				48Hz			
Water outlet(°C)	-30	-25	-20	-16	-15	-12	-7	-5	0	1	2	5	7	10	14	15	20	25	30	35															
35	/	6.05	7.32	8.42	8.72	10.30	12.06	12.84	13.82	13.93	14.34	14.75	14.95	15.88	15.70	15.94	17.31	17.70	17.24	18.80															
41	/	5.90	7.11	8.18	8.46	8.90	10.45	11.06	12.43	12.55	12.93	13.27	13.46	14.37	14.40	14.61	15.88	15.94	17.25	17.96															
45	/	5.75	6.95	8.00	8.28	8.70	10.16	10.82	12.17	12.27	12.64	12.97	13.16	13.97	13.87	14.07	15.39	15.57	16.97	17.65															
50	/	5.63	6.75	7.77	8.04	8.45	9.86	10.50	11.80	11.90	12.26	12.58	12.76	13.54	12.37	12.55	13.63	15.09	16.44	17.16															
55	/	5.42	6.54	7.52	7.78	7.60	8.86	9.43	10.55	10.63	10.95	11.24	11.39	12.17	11.91	12.08	13.12	13.12	15.02	16.76															
60	/	5.32	6.30	7.20	7.46	6.74	7.88	8.39	10.16	10.25	10.55	10.82	10.98	11.63	11.34	11.50	12.86	12.62	14.47	16.50															
65	/	/	5.65	6.46	6.68	6.47	7.56	8.06	8.69	8.75	9.01	9.52	9.66	10.22	10.37	10.52	11.42	10.74	12.31	11.72															
70	/	/	/	6.16	6.37	6.17	7.20	7.63	8.28	8.35	8.60	9.07	9.21	9.73	9.87	10.01	10.87	10.21	11.71	11.15															
75	/	/	/	/	/	/	6.82	7.22	7.48	7.80	8.05	8.58	8.81	9.18	9.30	9.45	10.24	/	/	/															
Power Input(kW)																																			
Water outlet(°C)	-30	-25	-20	-16	-15	-12	-7	-5	0	1	2	5	7	10	14	15	20	25	30	35															
35	/	2.84	2.91	2.94	2.94	3.05	3.11	3.14	3.20	3.23	3.25	3.26	3.29	3.32	2.95	2.95	2.98	2.90	2.30	2.36															
41	/	3.02	3.09	3.32	3.43	3.42	3.52	3.56	3.39	3.40	3.42	3.43	3.44	3.45	3.02	3.05	3.07	2.82	2.44	2.47															
45	/	3.11	3.21	3.46	3.58	3.58	3.61	3.65	3.69	3.61	3.61	3.36	3.41	3.47	3.25	3.26	3.22	2.95	2.66	2.68															
50	/	3.20	3.30	3.56	3.67	3.68	3.78	3.80	3.84	3.77	3.77	3.57	3.57	3.65	3.41	3.41	3.41	3.16	2.86	2.87															
55	/	3.28	3.40	3.67	3.79	3.52	3.57	3.63	3.64	3.65	3.65	3.68	3.71	3.72	3.24	3.27	3.30	2.92	3.01	3.04															
60	/	3.90	3.97	4.01	4.08	3.75	3.78	3.86	3.92	3.94	3.96	3.97	3.98	3.99	3.47	3.48	3.49	3.47	3.25	3.28															
65	/	/	4.24	4.30	4.36	4.23	4.38	4.50	4.23	4.16	4.17	4.12	4.11	4.22	3.91	3.93	3.95	3.63	3.74	3.75															
70	/	/	/	4.51	4.62	4.77	4.87	5.04	4.78	4.70	4.72	4.64	4.65	4.78	4.42	4.45	4.49	4.13	3.97	4.00															
75	/	/	/	/	/	/	5.15	5.08	4.65	4.71	4.72	4.77	4.79	4.88	4.75	4.77	4.79	/	/	/															

COP																				
Water outlet(°C)	-30	-25	-20	-16	-15	-12	-7	-5	0	1	2	5	7	10	14	15	20	25	30	35
35	/	2.13	2.52	2.86	2.97	3.38	3.88	4.09	4.32	4.31	4.41	4.52	4.54	4.78	5.32	5.40	5.80	6.11	7.51	7.96
41	/	1.96	2.30	2.46	2.47	2.60	2.97	3.11	3.67	3.69	3.78	3.87	3.91	4.17	4.76	4.80	5.17	5.65	7.08	7.27
45	/	1.85	2.17	2.31	2.31	2.43	2.82	2.97	3.30	3.40	3.50	3.86	3.86	4.02	4.27	4.32	4.79	5.27	6.38	6.59
50	/	1.76	2.05	2.18	2.19	2.29	2.61	2.76	3.07	3.16	3.25	3.52	3.58	3.71	3.63	3.68	3.99	4.77	5.75	5.98
55	/	1.65	1.92	2.05	2.06	2.16	2.48	2.60	2.90	2.91	3.00	3.05	3.07	3.27	3.68	3.69	3.97	4.49	4.98	5.52
60	/	1.36	1.59	1.80	1.83	1.80	2.09	2.17	2.59	2.60	2.67	2.73	2.76	2.92	3.27	3.30	3.68	3.63	4.45	5.03
65	/	/	1.33	1.50	1.53	1.53	1.73	1.79	2.05	2.11	2.16	2.31	2.35	2.42	2.65	2.68	2.89	2.96	3.29	3.13
70	/	/	/	1.37	1.38	1.29	1.48	1.51	1.73	1.78	1.82	1.95	1.98	2.04	2.23	2.25	2.42	2.47	2.95	2.79
75	/	/	/	/	/	/	1.32	1.42	1.61	1.66	1.71	1.80	1.84	1.88	1.96	1.98	2.14	/	/	/

COP																				
Water outlet(°C)	-30	-25	-20	-16	-15	-12	-7	-5	0	1	2	5	7	10	14	15	20	25	30	35
35	/	2.08	2.46	2.80	2.90	3.27	3.75	3.96	4.16	4.16	4.25	4.36	4.38	4.61	5.12	5.20	5.59	5.88	7.19	7.63
41	/	1.91	2.25	2.41	2.42	2.52	2.88	3.02	3.54	3.56	3.65	3.73	3.78	4.02	4.59	4.62	4.98	5.44	6.79	6.98
45	/	1.81	2.12	2.26	2.27	2.36	2.73	2.88	3.18	3.28	3.38	3.72	3.73	3.88	4.11	4.16	4.61	5.07	6.13	6.33
50	/	1.72	2.00	2.14	2.15	2.23	2.53	2.68	2.97	3.05	3.14	3.40	3.45	3.58	3.50	3.55	3.85	4.60	5.53	5.75
55	/	1.62	1.88	2.01	2.02	2.14	2.46	2.57	2.80	2.81	2.90	2.95	2.97	3.16	3.54	3.56	3.83	4.32	4.80	5.32
60	/	1.34	1.56	1.76	1.80	1.78	2.07	2.15	2.51	2.52	2.58	2.64	2.67	2.82	3.15	3.19	3.56	3.51	4.29	4.85
65	/	/	1.31	1.48	1.51	1.52	1.71	1.78	1.99	2.04	2.09	2.24	2.27	2.34	2.56	2.59	2.80	2.86	3.18	3.02
70	/	/	/	1.34	1.36	1.29	1.47	1.50	1.68	1.72	1.77	1.89	1.92	1.97	2.16	2.18	2.34	2.39	2.85	2.69
75	/	/	/	/	/	/	1.28	1.38	1.56	1.60	1.65	1.74	1.78	1.82	1.90	1.92	2.07	/	/	/

9.5 CH-HP22UIMPZM

Performance Curve
CH-HP22UIMPZM

Heating Capacity(kW)

			90Hz			84Hz			78Hz			72Hz			66Hz			60Hz			54Hz			48Hz		
Water outlet(°C)	-30	-25	-20	-16	-15	-12	-7	-5	0	1	2	5	7	10	14	15	20	25	30	35						
35	/	8.91	10.77	12.39	12.84	15.16	17.75	18.90	20.34	20.50	21.10	21.70	22.00	23.37	23.10	23.45	25.47	26.04	25.37	27.66						
41	/	8.68	10.46	12.04	12.45	13.09	15.38	16.28	18.30	18.46	19.02	19.52	19.81	21.15	21.20	21.50	23.37	23.45	25.39	26.43						
45	/	8.47	10.23	11.77	12.18	12.81	14.96	15.92	17.91	18.06	18.60	19.09	19.36	20.56	20.42	20.71	22.65	22.92	24.97	25.97						
50	/	8.28	9.93	11.43	11.83	12.44	14.51	15.45	17.37	17.52	18.04	18.51	18.78	19.93	18.20	18.47	20.07	22.23	24.19	25.25						
55	/	7.97	9.62	11.07	11.46	11.18	13.03	13.87	15.52	15.64	16.11	16.54	16.76	17.92	17.53	17.77	19.30	19.84	22.10	24.66						
60	/	7.83	9.28	10.60	10.97	9.92	11.60	12.35	14.95	15.09	15.53	15.93	16.16	17.11	16.69	16.92	18.92	19.13	21.29	24.27						
65	/	/	8.31	9.51	9.83	9.52	11.13	11.85	12.78	12.88	13.26	14.02	14.22	15.05	15.26	15.48	16.81	16.83	18.11	17.25						
70	/	/	/	9.06	9.38	9.08	10.60	11.23	12.19	12.29	12.66	13.35	13.56	14.32	14.53	14.73	16.00	16.05	17.23	16.41						
75	/	/	/	/	/	/	10.03	10.63	11.01	11.48	11.85	12.63	12.96	13.51	13.69	13.90	15.07	/	/	/						

Power Input(kW)

Water outlet(°C)	-30	-25	-20	-16	-15	-12	-7	-5	0	1	2	5	7	10	14	15	20	25	30	35
35	/	4.21	4.30	4.35	4.35	4.56	4.65	4.69	4.81	4.85	4.88	4.90	4.94	4.99	4.43	4.43	4.48	4.35	3.45	3.54
41	/	4.46	4.57	4.92	5.07	5.11	5.26	5.32	5.09	5.11	5.14	5.15	5.17	5.18	4.54	4.57	4.61	4.23	3.66	3.71
45	/	4.60	4.74	5.12	5.29	5.35	5.39	5.45	5.54	5.42	5.42	5.04	5.12	5.22	4.88	4.89	4.83	4.44	3.99	4.02
50	/	4.74	4.88	5.26	5.42	5.51	5.65	5.68	5.77	5.65	5.66	5.37	5.36	5.49	5.11	5.13	5.13	4.75	4.30	4.31
55	/	4.85	5.03	5.42	5.60	5.15	5.23	5.31	5.47	5.48	5.48	5.53	5.57	5.59	4.87	4.91	4.96	4.51	4.52	4.56
60	/	5.77	5.87	5.93	6.03	5.49	5.53	5.65	5.89	5.92	5.95	5.96	5.98	5.99	5.21	5.23	5.24	5.38	4.88	4.93
65	/	/	6.27	6.36	6.45	6.19	6.41	6.59	6.36	6.24	6.27	6.18	6.18	6.34	5.87	5.89	5.93	5.80	5.62	5.63
70	/	/	/	6.67	6.84	6.98	7.13	7.38	7.17	7.05	7.09	6.97	6.99	7.18	6.64	6.68	6.74	6.63	5.96	6.01
75	/	/	/	/	/	/	7.74	7.63	6.99	7.07	7.09	7.16	7.19	7.32	7.13	7.17	7.20	/	/	/

COP																				
Water outlet(°C)	-30	-25	-20	-16	-15	-12	-7	-5	0	1	2	5	7	10	14	15	20	25	30	35
35	/	2.12	2.51	2.85	2.95	3.33	3.82	4.03	4.23	4.23	4.32	4.43	4.45	4.69	5.21	5.29	5.69	5.99	7.36	7.80
41	/	1.95	2.29	2.45	2.46	2.56	2.93	3.06	3.59	3.62	3.70	3.79	3.83	4.08	4.67	4.70	5.07	5.54	6.94	7.13
45	/	1.84	2.16	2.30	2.30	2.39	2.77	2.92	3.23	3.33	3.43	3.78	3.78	3.94	4.18	4.23	4.69	5.17	6.25	6.45
50	/	1.75	2.04	2.17	2.18	2.26	2.57	2.72	3.01	3.10	3.19	3.45	3.50	3.63	3.56	3.60	3.92	4.68	5.63	5.86
55	/	1.64	1.91	2.04	2.04	2.17	2.49	2.61	2.84	2.85	2.94	2.99	3.01	3.21	3.60	3.62	3.89	4.40	4.88	5.41
60	/	1.36	1.58	1.79	1.82	1.81	2.10	2.19	2.54	2.55	2.61	2.67	2.70	2.86	3.20	3.24	3.61	3.56	4.36	4.93
65	/	/	1.33	1.49	1.52	1.54	1.74	1.80	2.01	2.06	2.12	2.27	2.30	2.37	2.60	2.63	2.83	2.90	3.22	3.07
70	/	/	/	1.36	1.37	1.30	1.49	1.52	1.70	1.74	1.79	1.91	1.94	1.99	2.19	2.21	2.37	2.42	2.89	2.73
75	/	/	/	/	/	/	1.30	1.39	1.58	1.62	1.67	1.76	1.80	1.84	1.92	1.94	2.09	/	/	/

10. Explosion View

Model and code: **CH-HP09UIMPZK**

A. Whole Unit Exploded Diagram

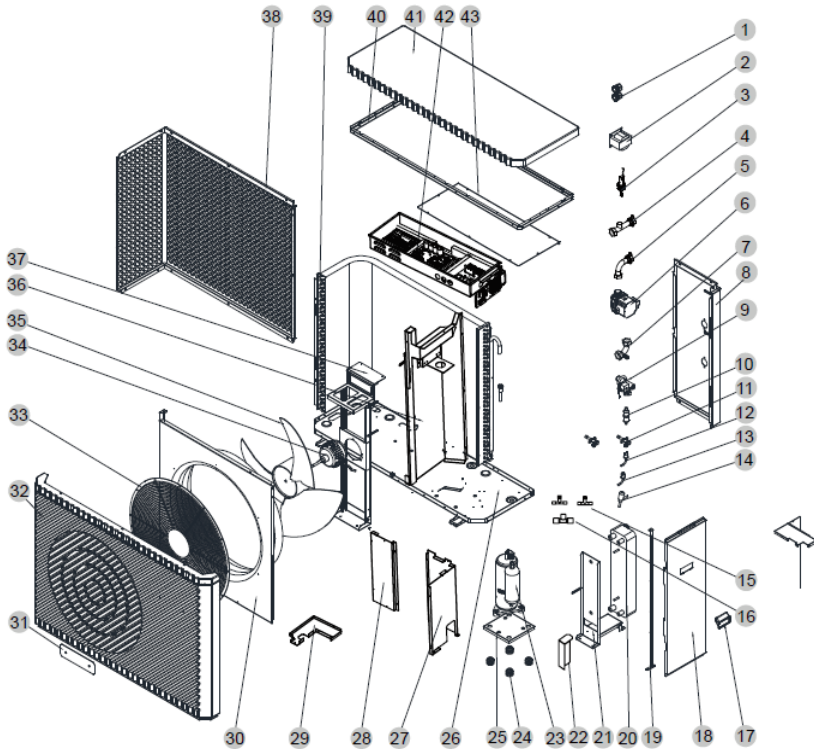

B. Electric Box Exploded Diagram

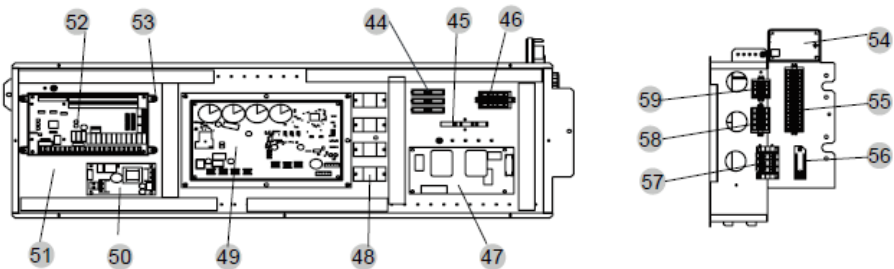

No.	Code	Name	Qty
1	2001-2238	Waterproof cable feedthrough (black)	2
2	82500015	Reactor	1
3	20000-360005	Water flow switch (die sinking)	1
4	81500471	Outlet pipe fitting assembly	1
5	81800469	Inlet pipe fitting assembly	1
6	80400057	Water pump (GRUNDFOS)	1
7	81800470	Water pump fitting assembly	1
8	80713153	Right rear side plate assembly	1
9	20000-140485	Four-way valve and accessories	1
10	2004-1444	Filter	2
11	81000043	Shut-off valve	2
12	83000187	Pressure switch	1
13	83000185	Pressure switch	1
14	20000-140573	Electronic expansion valve	1
15	2000-1460	Tee	2
16	304030-00000002	Tee	1
17	32018-220009	Handle	1
18	80711961	Right side plate assembly	1
19	80711967	Panel support	1
20	80601397	Plate heat exchanger	1
21	80711960	Plate heat exchanger support assembly	1
22	80708062	Water pump support	1
23	80100175	Compressor and accessories (P95)	1
24	20000-260005	Press shock absorbing feet	4
25	80712312	Suspension chassis	1
26	80711959	Base plate assembly	1

No.	Code	Name	Qty
27	80711973	Compressor cover I	1
28	80711974	Compressor cover II	4
29	80711976	Compressor cover	1
30	80711966	Round air duct	1
31	80709942	Trademark base	1
32	80900723	Front frame assembly	1
33	80708055	Fan grille	1
34	80200153	DC motor	1
35	20000-270073	Axial flow fan blade	1
36	80711970	Middle baffle plate assembly	1
37	80711971	Motor support assembly	1
38	80711963	Rear net assembly	1
39	80601206	Finned heat exchanger	1
40	80711962	Top beam assembly	1
41	80900722	Top cover assembly	1
42	/	Electrical control components	1
43	80711977	Electrical box cover	1
44	2000-3909	2-Position terminal block	3
45	20000-390077	Fuse terminal	1
46	/	Terminal block 1	1
47	302010-00000007	Variable frequency drive filter board	1
48	20000-360297	Relay	1
49	82300284	Variable frequency drive module assembly	1
50	82600018	Switching power supply module	1
51	80711972	Electrical box assembly	1
52	80900483	PC4003	1

No.	Code	Name	Qty
53	80900486	Plastic base	1
54	82300225	DTU1007	1
55	/	Terminal block 1	1
56	20000-220316	Cable clamp	1
57	20000-390223	3-Position terminal block	1
58	/	Terminal block 2	1
59	/	Terminal block 3	1

11. Wiring Diagram

11.1. Model: CH-HP09UIMPZK

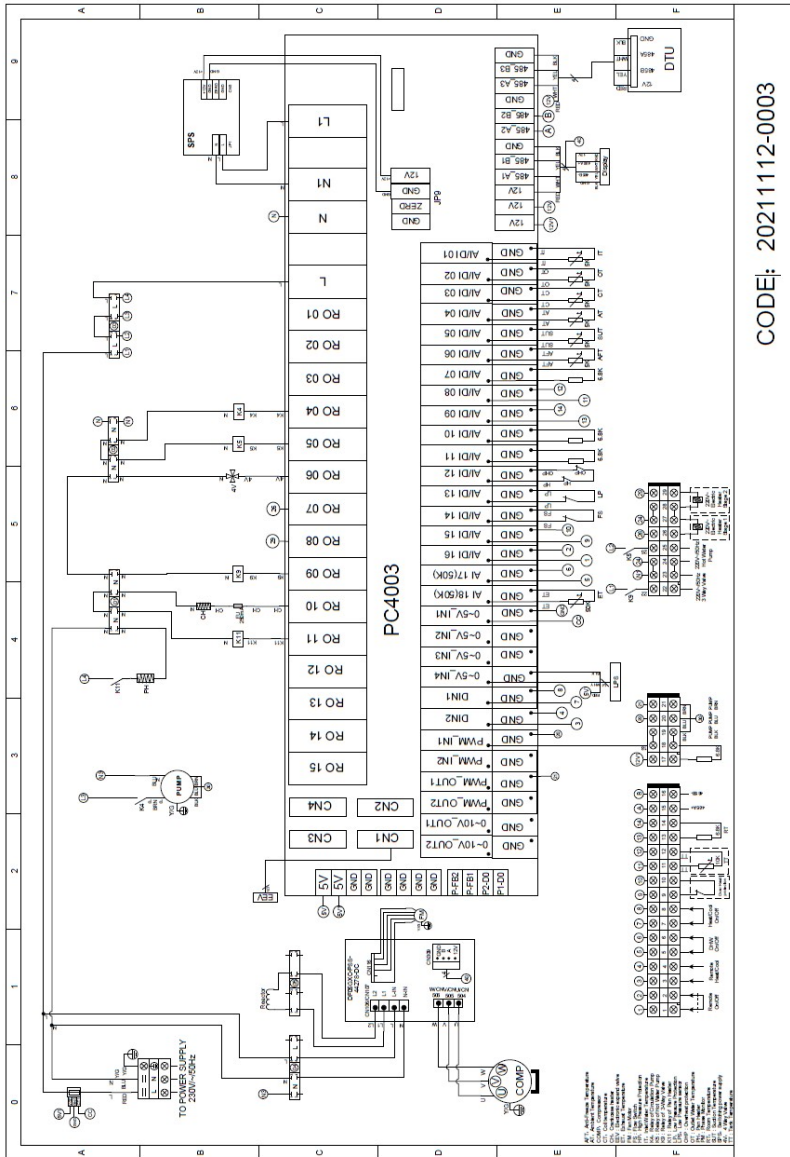

11.3. Model: CH-HP22UIMPZM

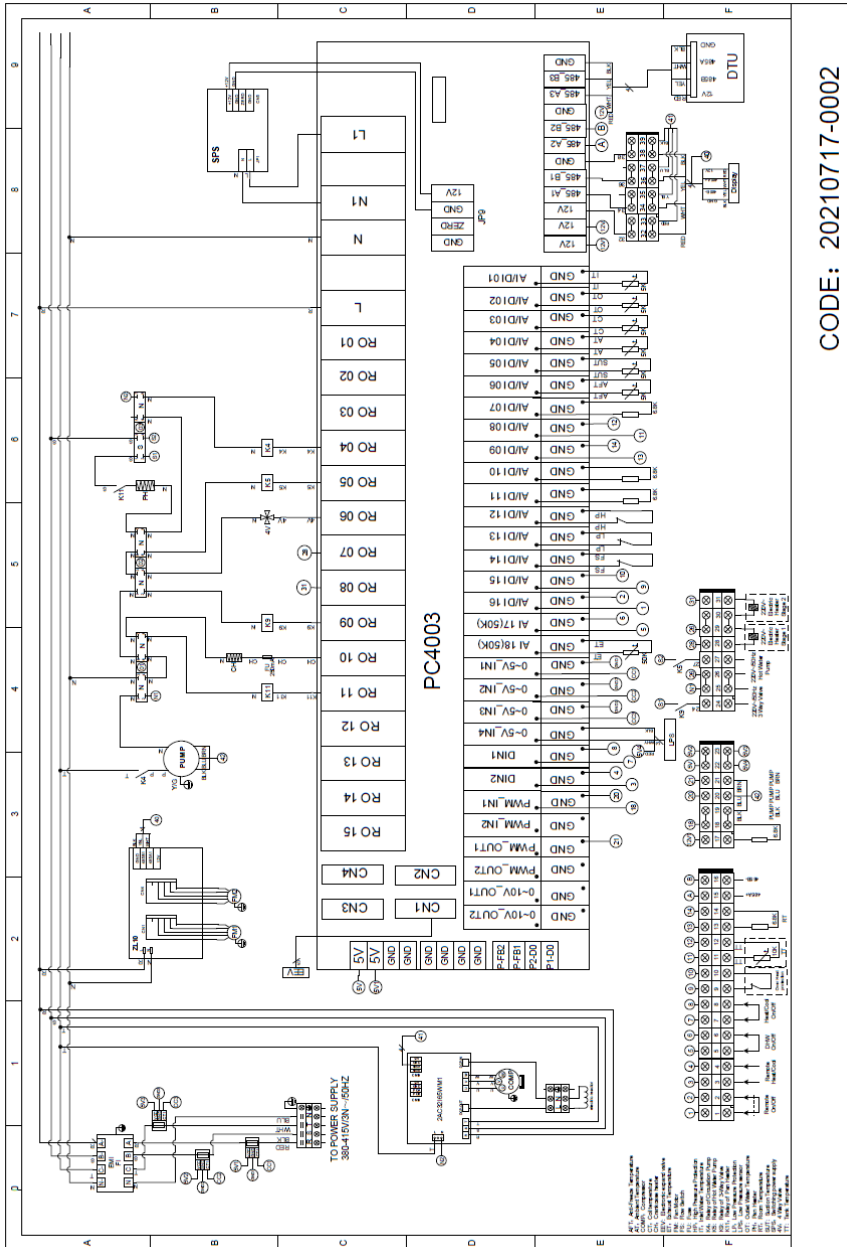

CODE: 20210717-0002

12. Display Operation Guide

12.1. Main Interface Display and Function

(1) Power on Interface

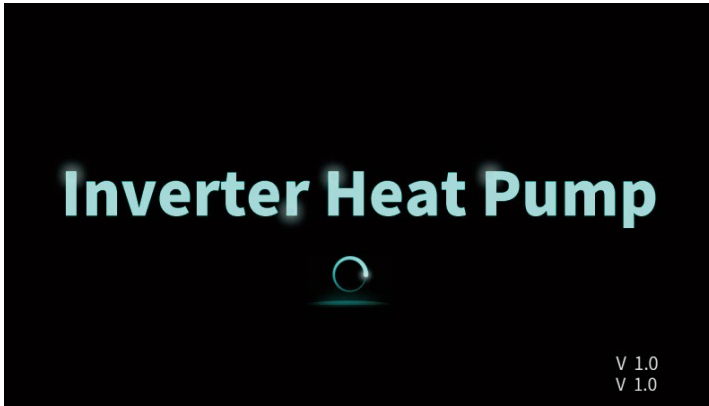

(2) Starting up Interface



Key function

Key number	Key name	Key Function
①	Lock screen	Click this key to lock the screen. White represents not enabled, while blue represents enabled
④	On and off	Click this key to switch ON or OFF. Blue represents ON, while white represents OFF
⑤	Temperature setting	Click this key to set the target temperature
⑮	Mode key	Hot water mode, heating mode, cooling mode, hot water+ heating mode or hot water+ cooling mode can be selected by pressing this key

Note:

② is home icon. This icon is shown by sliding the main interface.

③ is tank water temperature. The machine is in hot water mode when this icon is shown; Otherwise this icon is not shown.

⑥ is outlet water temperature or room temperature. If H25=0, the outlet water temperature will be shown. If H25=1, the room temperature will be shown.

⑦ is Target Temperature of No.1 Unit.

⑧ is fault icon. This icon will flash when there is an error shown up, then the display will enter failure record interface after tapping this icon;

⑨ is defrosting icon. It will display in the defrosting process of the unit.

⑩ is timing mute icon which displays only when activated.

⑪ is timing switch which displays only when activated.

⑫ is ambient temperature.

⑬ is system time.

⑭ is current mode.

12.2. ON/OFF

(1) In shutting down interface (on/off key is in white status), press on/off key can start up the machine.



(2) In starting up interface (on/off key is in blue status), press on/off key can shut down the machine.

12.2.1. Mode switch

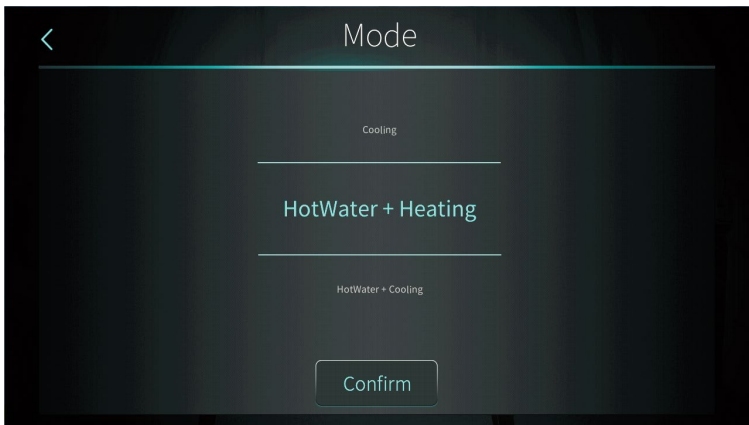

There are five modes can be selected after sliding the mode icon.

(1) selecting hot water mode icon, then the display will change to this mode interface;

- (2) selecting heating mode icon, then the display will enter this mode interface;
- (3) selecting cooling mode icon, then the display will switch to this mode interface;
- (4) selecting hot water+ heating mode icon, then the display will go into hot water+ heating mode interface;
- (5) selecting hot water+ cooling mode icon, then the display will come to hot water+ cooling mode interface;

Note: a) If the machine model you purchased has no cooling function, the key of cooling mode will not be displayed.

b) If the machine model you purchased has no hot water function, the key of hot water mode function will not be displayed.

In the main interface, there are five modes that can be selected after tapping the mode key.

- (1) tapping hot water mode icon ①, then the display will change to this mode's interface;
- (2) tapping heating mode icon ②, then the display will enter this mode's interface;
- (3) tapping cooling mode icon ③, then the display will switch to this mode's interface;
- (4) tapping hot water + heating mode icon ④, then the display will go into the hot water + heating mode's interface;
- (5) tapping hot water + cooling mode icon ⑤, then the display will come to the hot water + cooling mode's interface;

Note: If your unit is a heating-only model (without a cooling function), the "cooling" key will show on the interface.

12.3. Setting of target temperature

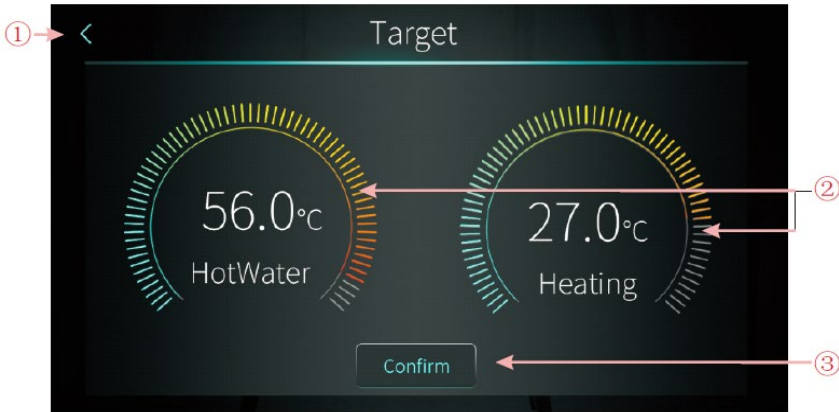

Take hot water + heating mode for example:

- (1) Tapping ①, the wire controller back to main interface;
- (2) Sliding ②, the target temperature can be adjusted in the clockwise or counter clock--wise direction;
- (3) Tapping ③, the target temperature can be saved.

12.3.1. Unlock screen

Click the lock screen key again while the screen has been locked, pop-up keyboard is shown as following:

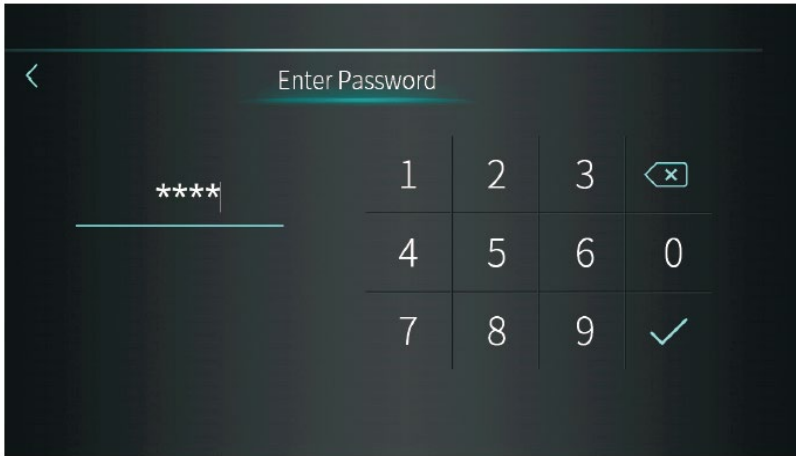

Note: Input the password of 22 or 022, click the enter key and the screen will be unlocked.

12.4. Setting interface display and function

Swipe from right to left on the main interface to enter the function setting interface, and swipe from left to right on the function setting interface to return to the main interface. The function setting interface is shown in the figure below.

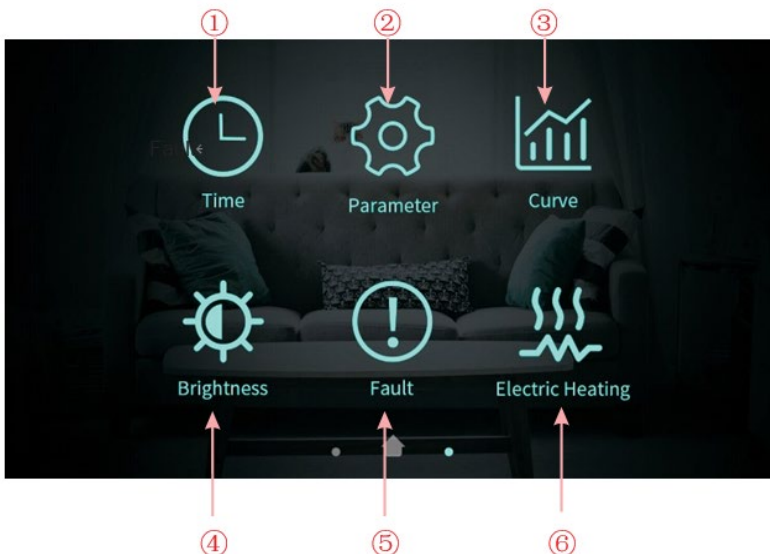

12.4.1. Buttons description

Key number	Key name	Key function
①	Time setting	Click this key to set the time function.
②	Factory parameter	Click the key and enter the password to enter the factory parameter settings and status parameters interface.
③	Curve key	Click this key to view the temperature curve.
④	Adjust brightness	Click this button to adjust screen brightness
⑤	Fault	Click to view fault history
⑤	One key electric heating	When activate electric heating function, the color of the icon will turn blue, otherwise it will turn white.

12.4.2. Time setting

In the setup interface:

(1) Tapping the button①, then the interface display is shown as follows:

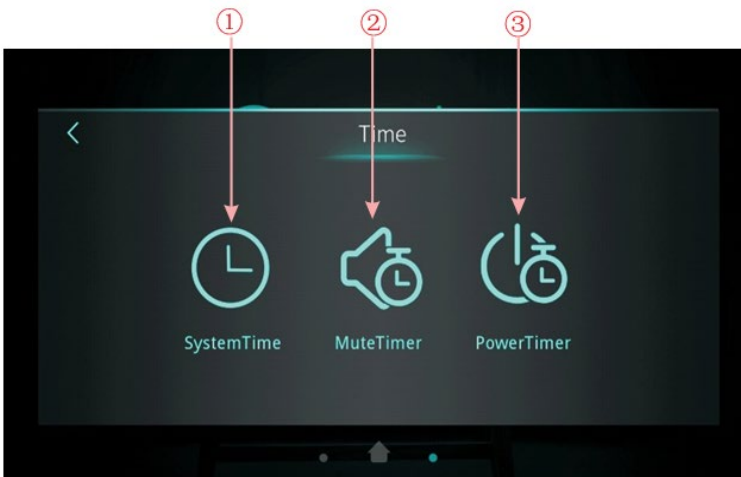

12.4.3. System time setting

In the time setting interface, click ① interface displays as follows:



When entering the page of system time setting, the system time will be initialized to the time at the moment when the system time setting will be pressed, and you can adjust the time by sliding up and down.

Note: When the temperature unit is? the time format is displayed as: month-day-year hour: minute: second.

12.4.4. Mute Timer setting

Click the lock screen key again while the screen has been locked, the pop-up keyboard is shown as following:

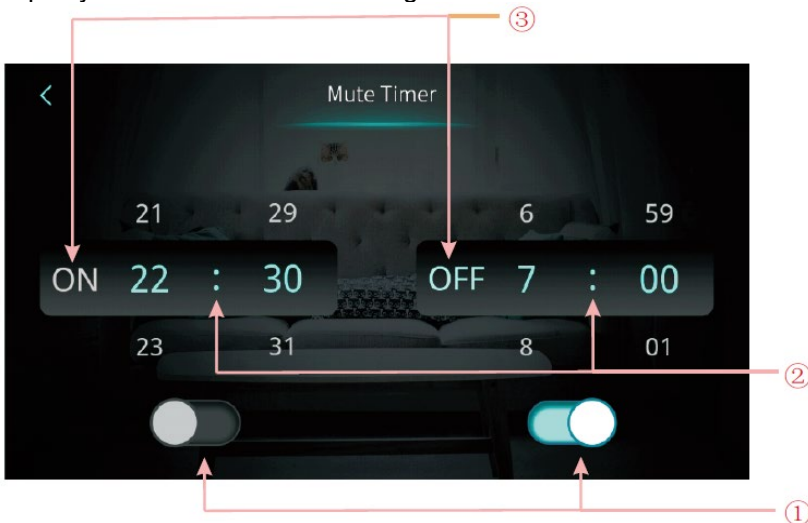

NO.	Name	Key color	Button function
①	Whether enable the mute timer on function	Enable: Blue Disable: Gray	Click this key to enable or disable the mute timer on function
	Whether enable the mute timer off function	Enable: Blue Disable: Gray	Click this key to enable or disable the mute timer off function
②	The mute timer on setting point		select from 0:00-23:59
	The mute timer off setting point		select from 0:00-23:59
③	The status of mute timer on	Enable: Blue Disable: Gray	The status of mute timer on is shown
	The status of mute timer off	Enable: Blue Disable: Gray	The status of mute timer on is shown

12.4.5. Power Timer setting

In the time setting interface, click ③ interface displays as follows:

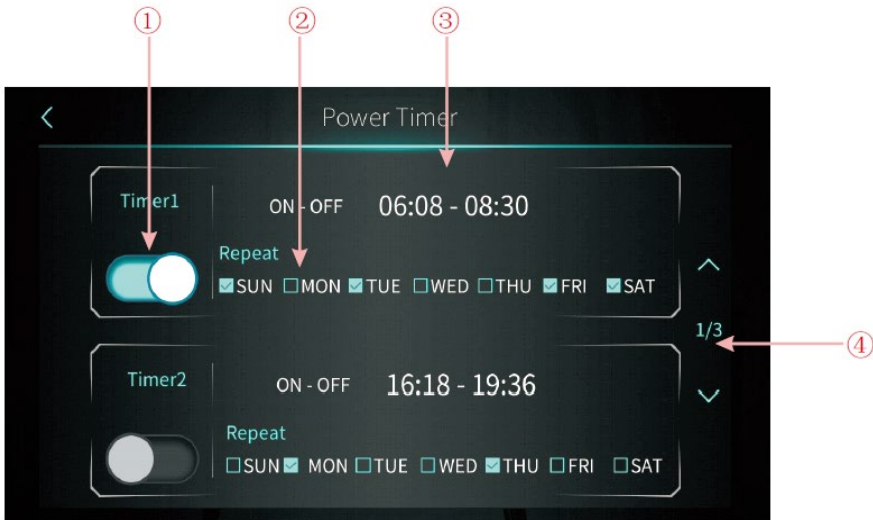

NO.	Name	Button function
①	Timing switch function on	Clicking the button, when the font color is blue, the timing switch is on
②	Week setting	Set the day of the week to activate the timing switch

③	Time period setting	Set the time to turn on and the time to turn off
④	Turn page	A total of 6 timing switch time periods can be set which can be selected by turning the page

12.4.6. Temperature Curve

In the setup interface:

Tapping operating mode button④, then the interface display is shown as follows:

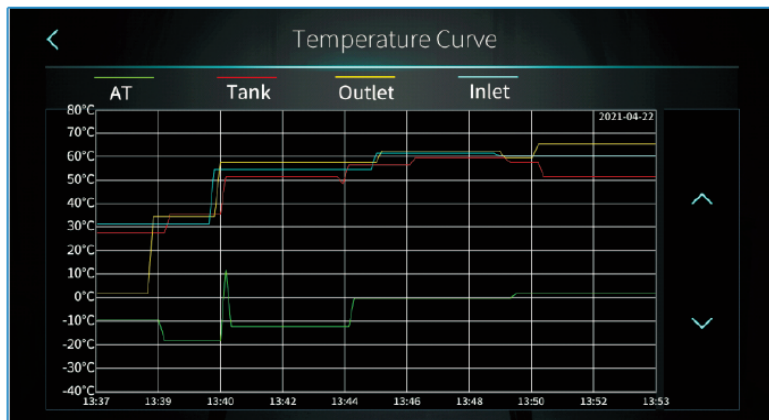

Note:

- 1) This curve function records the water inlet temperature, water outlet temperature, tank water temperature and ambient temperature;
- 2) Temperature data is collected and saved every five minutes. Timekeeping is made from the latest data saving, if the power is disrupted when the time is less than five minutes, the data during such period will not be saved;
- 3) Only curve for power-on status is recorded, and that for power-off will not be saved;
- 4) The value of the abscissa indicates the time from the point on the curve to the current time point. The rightmost point on the first page is the latest temperature record;
- 5) Temperature curve record is provided with power-down memory function.

12.4.7. Color Display Calibration

In the setting interface: Tapping operating mode button⑤, then the interface display is shown as follows:

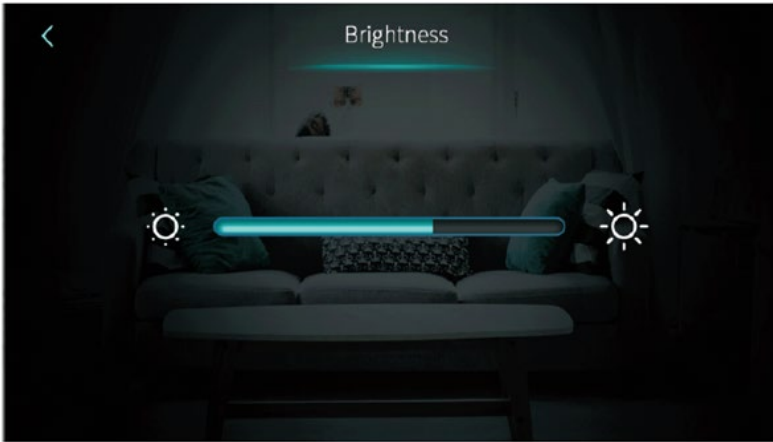

Note:

- 1) The middle display bar can be dragged or clicked to adjust the brightness of the screen with power-down memory.
- 2) Press the back key to return to the previous level and save the brightness setting value.
- 3) The screen has the function of automatic on and off, if there is no operation for 30s, the screen will enter the half-time screen state.
- 4) If there is no operation for another 5 minutes (a consecutive 5 minutes), the screen will enter the screen state.

12.4.8. Electric Heating

In the setup interface: Tapping operating mode button ⑥, then the interface display is shown as follows:

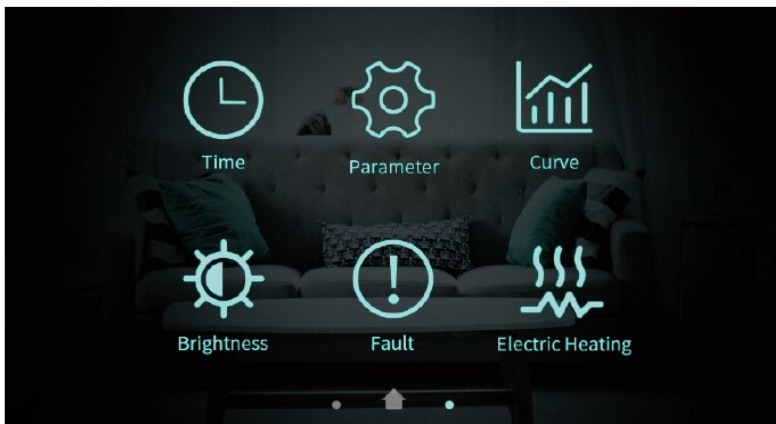

Note: If you enter one-key electric heating, the icon is blue, otherwise it is gray.

12.5. Status interface display

Swipe from left to right on the main interface to enter the status interface, and swipe from right to left on the status interface to return to the main interface. The status interface is shown in the figure below.

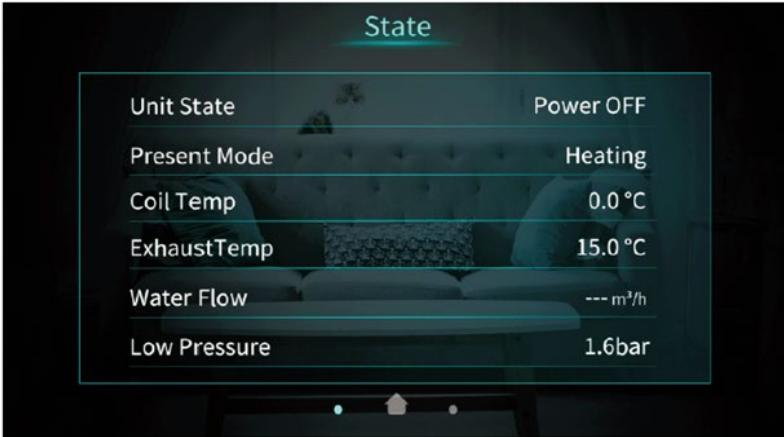

12.6. Fault interface display and function



①: Fault code

②: Fault name

③: Occurrence time of the fault: Day an month hour: minute: second Note:
If the current temperature is °F, occurrence time of the fault: Month and day
hour: minute: second.

④: Click this key to clear all fault records

13. Electrical Parameter

Parameter	Meaning	Scope	Default value	Remarks
A	Protection parameters			
A03	Shutdown Ambient Temp.	-40.0~10.0°C	-25°C	
A04	Antifreeze Temp.	A22~10°C	4°C	
A05	Antifreeze Temp. Difference	1.0~50.0°C	3°C	Non-zero
A06	Max. Exhaust Temp.	60.0~130.0°C	115°C	Non-zero
A11	Enable Low Pressure Sensor	0-Disable/1-Enable [0-No/1-Yes]	1	0-Disable/1-Enable
A21	Ambient/Suction/Coil Sensor Type	0-5K/1-2K	0	0-5K/1-2K
A22	Min. Antifreeze Temp.	-20.0~10.0°C	4°C	
A23	Min. Outlet Water Temp. Protect	-30~20°C	5°C	-30~20°C
A24	Excess Temp. Diff. Between Inlet and Outlet Temp.	0~30°C	9.5°C	0~30°C
A25	Minimum Evaporation Temp. of Cooling	-50°C~30°C	-10°C	-50°C-30°C
A26	Refrigerant Type	0-R32/1-R290	0	0-R32/1-R290
A27	Temp. Diff. of Limiting Frequency	-20~20°C	7°C	
A28	Temp. Diff. Between Outlet and DHW Temp.	-20~20°C	7°C	
A29	Enable High Pressure Sensor	0- 【NO】 /1- 【YES】	0	
H				
	Enable Power-off Memory	0- 【No】 /1- 【Yes】	1	
H05	Enable Cooling Function	0- 【No】 /1- 【Yes】	1	0-Disable/1-Enable
H07	Control Mode	0- 【Display/Wire Controller】 /1- 【Dry Contact】	0	
H10	Unit Address	1~32	1	
H18	Electric Heater Stage	1- 【Stage1】 /2- 【Stage2】 /3- 【Stage3】	3	1-Electric heating energy level I 2-Electric heating energy level II 3-Electric heating energy level III
H20	3-Way Valve Polarity	0- 【Hot Water-ON】 /1- 【Hot Water-OFF】	0	
H21	Temperature Unit	0- 【°C】 /1- 【°F】	0	0-°C/1-°F

H22	Enable Silent Mode	0- 【No】 /1- 【Yes】	1	When H22=0, there is no interface and key related to mute function on the wired controller
H25	Temp. Control Selection	0- 【Outlet Water Temp.】 1- 【Room Temp.】 /2- 【Buffer Tank Temp.】/3- 【Inlet Water Temp.】	0	
H27	Enable EVI	0- 【No EVI】 /1- 【EVI for Cooling】 /2- 【EVI for Heating】 /3- 【All EVI】	3	
H28	Heating/Cooling and Hot Water Function Enabled	0- 【No】 /1- 【Yes】	1	
H29	Operation Code	0-20	0	
H30	Enable Hydraulic Module	0- 【No】 /1- 【Yes】	0	0-Disable/1-Enable
H31	Circulation Pump Type	0- 【No Flow Detection】 1- 【Grundfos(25~75)】 2- 【Grundfos(25~105)】 3- 【Grundfos(25~125)】	0	0-No Flow Detection 1-Grundfos (25~75) 2-Grundfos (25~105) 3-Grundfos (25~125)
H32	Force Switch Mode Time	1~300min	120min	1~120min
H33	Fan Motor Driver and Comp. Driver Integrated	0- 【No】 /1- 【Yes】	0	0-Not integrated/1-integrated
H34	ERP Testing Mode	0-Not Enabled 1-35℃ Working Condition 2-55℃ Working Condition	0	0-Disable 1-35℃ working condition 2-55℃ working condition Do not place in customer parameters
C	Compressor parameters			
C01	Manual Comp. Frequency	0~120Hz	0	
C02	Min. Comp. Frequency	20~60Hz	30	
C03	Max. Comp. Frequency	30~120Hz	90	
C04	Model Selection	0~99	0	For the setting of the compressor model,

				please refer to the compressor selection chart in the communication protocol of Rujing frequency conversion board
C05	Min. Comp. Frequency in Cooling at Low Ambient Temp.	0~60Hz	50	
C06	Frequency Control Mode	1~120	1	
C07	Resonance Point 1	0~120HZ	0	0~120Hz
C08	Resonance Point 2	0~120HZ	0	0~120Hz
C09	Resonance Point 3	0~120HZ	0	0~120Hz
C10	Min. Comp. Frequency in Heating at Low Ambient Temp.	0~120HZ	60	0-120Hz
C11	Max. Comp. Frequency in Cooling at High Ambient Temp.	0~120HZ	66	0-120Hz
F	Fan parameters			
F01	Fan Motor Type	0- 【High】 /1- 【Double】 /3- 【DC】	3	
F02	Coil Temp.. for Max. Fan Speed in Cooling	-15.0~60.0℃	50℃	
F03	Coil Temp.. for Min. Fan Speed in Cooling	-15.0~60.0℃	10℃	
F05	Coil Temp.. for Max. Fan Speed in Heating	-15.0~60.0℃	10℃	
F06	Coil Temp.. for Min. Fan Speed in Heating	-15.0~60.0℃	20℃	
F10	Fan Quantity	0- 【 One fan 】 /1- 【 Two fans 】	0	
F18	Min. Fan Speed in Cooling	10~1300r	300r	Non-zero
F19	Min. Fan Speed in Heating	10~1300r	300r	Non-zero
F21	Enable Timer Mute	0- 【No】 /1- 【Yes】	0	
F22	Enable Manual-control Fan Speed	0- 【No】 /1- 【Yes】	0	
F23	Rated DC Fan Motor Speed	10~1300r	600r	Non-zero
F25	Max. Fan Speed in Cooling	10~1300r	700r	
F26	Max. Fan Speed in Heating	10~1300r	700r	
F27	Fan Motor Power Curve	0-100	0	
E	Electronic expansion valve parameters			

E01	EEV Adjust Mode	0- 【Manual】 /1- 【Auto】	1	
E02	Target Superheat for Heating	-20.0~20.0℃	5℃	
E03	EEV Initial Steps for Heating	0~500N	350	
E07	EEV Min. Steps	0~500N	100	
E08	EEV Initial Steps for Cooling	0~500N	200	
E09	EVI EEV: Adjustment Mode	0- 【Manual】 /1- 【Auto】	1	
E10	EVI EEV: Initial Steps	0~500N	350N	
E13	EVI EEV Target Superheat Degree	-20.0~20.0℃	3℃	
E14	EVI EEV Min. Steps	0~500N	100N	
E17	Defrosting EEV Steps	10~500N	480	
E18	Target Superheat for Cooling	-10.0~10.0℃	3℃	
E19	EEV Adjustment Range In Smart Mode	0%--300%	20	0%--300%
D	Defrost parameters			
D01	Ambient Temp. of Starting Defrosting	-37~45℃	12.5℃	
D02	Heating Operation Time Before Defrosting	0~120min	26 min	
D03	Interval Time Between Defrosting Cycles	30~90min	45 min	
D04	Exhaust Temp. Correction for Defrosting Cycle	0~150℃	110℃	
D05-1	Defrosting Suction Pressure 1	0~45bar	2.6bar	
D05-2	Defrosting Suction Pressure 2	0~45bar	1.7bar	
D06	Defrosting Cycle Time Correction	0~120min	15 min	
D07	Ambient Temp. of Start Sliding Defrosting	-37~45℃	6.1℃	
D08	Suction Temp. of Start Sliding Defrosting	-37~45℃	-4.1℃	
D09	Ambient Temp. of Stop Sliding Defrosting	-37~45℃	-26.1℃	
D10	Suction Temp. of Stop Sliding Defrosting	-37~45℃	-28.1℃	
D11	Min. Inlet Water Temp. of Defrosting	4~65℃	23℃	
D12	Suction Pressure of Forced Defrosting	0~45bar	2bar	
D13	Heating Operation Time Before Forced Defrosting	0~120min	120 min	
D14	Fan Motor Power Ratio to Extend Defrosting Cycle	0 - 5.00	1.30	
D15	Fan Motor Power Ratio to Enter Forced Defrosting	0 - 5.00	1.50	
D16	Max. Fan Motor Power to Enter Forced Defrosting	50 - 1000W	200W	
D17	Coil Temp. of Exit Defrosting	-37~45℃	13℃	
D18	Distributor Tube Temp. of Exit Defrosting	-37~45℃	33℃	
D19	Max. Defrosting Time	0~20min	8 min	

D20	Defrosting Frequency	30~90Hz	70Hz	
D21	Enable Electric Heater During Defrosting	0-NO/1-YES	1	
D22	Water Flow of Defrosting	0-50.00m³/h	0	0 is disable by default
D23	Max. Defrosting Cycle by Fan Motor Power	0~240min	120min	
R				
R01	Domestic Hot Water / DHW Target Temp.	R36~R37	55°C	
R02	Heating Target Temp.	R10~R11°C	45°C	
R03	Cooling Target Temp.	R08~R09°C	7°C	
R04	Temp. Diff. for Power-on in Heating	0~10°C	2°C	
R05	Temp. Diff. for Standby in Heating	0~10°C	1°C	
R06	Temp. Diff. for Power-on in Cooling	0~10°C	2°C	
R07	Temp. Diff. for Standby in Cooling	0~10°C	1°C	
R08	Min. Cooling Target Temp.	-30.0~R09°C	5°C	
R09	Max. Cooling Target Temp.	R08~80.0°C	28°C	
R10	Min. Heating Target Temp.	-30.0~R11°C	15°C	
R11	Max. Heating Target Temp.	R10~99°C	60°C	
R15	Temp. Diff. of Exiting Over-high Outlet Temp.	0~15°C	2°C	
R16	Temp. Diff. for Power-on in DHW	0~10°C	5°C	
R17	Temp. Diff. for Standby in DHW	0~10°C	2°C	
R29	Low AT for Water Temp. Limit On	R30~4°C	-5°C	
R30	Low AT for Water Temp. Limit Off	-35~R29°C	-23°C	
R31	Max. Limit Outlet Water Temp. at Low AT	20~85°C	40°C	Non-zero
R32	High AT for Water Temp. Limit On	10~R33°C	55°C	Non-zero
R33	High AT for Water Temp. Limit Off	R32~60°C	55°C	Non-zero
R34	Max. Limit Outlet Water Temp. at High AT	20~85°C	45°C	Non-zero
R35	Location of Electric Heater	0- 【Not used】 /1- 【Waterline】 /2- 【Water-Tank】	0	
R36	Min. DHW Target Temp.	0~R37°C	15°C	0-R37°C
R37	Max. DHW Target Temp.	R36~85°C	58°C	R36-60°C
R39	AT for Auto-start Heating Mode	5~20°C	10°C	-10-10°C
R40	AT for Main Circulation Pump in Smart Mode	-10~60°C	55°C	2~20°C
R41	AT for DHW Pump in Smart Mode	-10~60°C	55°C	2~60°C
R42	Max. Outlet Water Temp. in Heating	20~ 85°C	60°C	20~60°C

R43	Max. Limit Target Water Temp. at Low AT in Heating	20~85°C	50°C	20~60°C
R44	Max. Limit Target Water Temp. at High AT in Heating	20~85°C	40°C	20~60°C
R45	AT to Start Electric Heater Without Delay	-50~20°C	-10°C	-50~20°C
R46	Temp. Diff. between Max. DHW Target Temp. & Max. Outlet Temp.	0~25°C	5°C	0~15°C
R60	AT to Start Frequency Limit in Cooling	0-60°C	25°C	0~60°C
R61	AT to Stop Frequency Limit in Cooling	0-60°C	45°C	0~60°C
R62	Max. Heat Pump Outlet Water Temp.	40-95°C	62°C	40~95 °C (can not be 0)
P	Circulating water pump parameters			
P01	Operating mode of circulating water pump(0-Normal/1-Special/2-Intermittent)	0-Normal/1-Special/2-Intermittent	2	
P02	Circulating water pump operation interval	1~120min	30 Min	Non-zero
P03	Circulating water pump operation duration	1~30min	3 Min	Non-zero
P05	Operating mode of domestic hot water pump(0-Normal/1-Special/2-Intermittent)	0-Normal/1-Special/2-Intermittent	2	
P06	Manually controlled water pump	0- 【No】 /1- 【Yes】	0	
P08	【Water Pump Rating Power】	0-2000W	0	
G	Disinfection parameters			
G01	Disinfection Water Temp.	60~70°C	63°C	
G02	Time Duration of Disinfection	0~60min	0min	
G03	Disinfection Starting Time	0~23h	1:00 AM	
G04	Interval Period of Disinfection	1~30Days	30	
G05	Enable Disinfection	0- 【No】 /1- 【Yes】	1	

14. Failure List & Troubleshooting

14.1. Failure Handling

Issue	Possible cause	Related components	Solution
Unit tripped when powered on	Short circuit	Terminals Relays Contactors cables	Check all the components' connection Check relays and contactors whether are broken Disconnect the electronic components one by one and powered on to find the problem
Display cannot get power	Cables has disconnected The power input cable is mis-connected	Display cable Power input cable	Check the display cable Check the power cable Check the 3-phase power cable whether connected in right phase sequence
cannot start up the unit	The unit have error Cables has disconnected	Display Cables	Check the display whether shown error Check the cable Reconnect the power cable and check if it works
Display cannot work	The display has been locked The display is broken	Display	Check the display whether shown locked icon Check the cable Reconnect the power cable and check if it works
Heating effect is not good	The compressor running low frequency The fan is not running or speed is too low Leakage problem	Compressor Fan Refrigerant system	Check the compressor frequency Check the fan speed Check the exhaust temperature and low pressure
Shut off while didn't reach the target temperature	Temperature limit (according to ambient temperature)	Control logic	Check the parameters
The evaporator has too much frost and cannot defrosting cleanly	Fan blade or motor issue EEV step is not suitable Refrigerant amount issue Parameter issue	Parameters Fan EEV Refrigerant system	Check the defrosting parameters Check the compressor frequency Check the fan speed Check the exhaust temperature and low pressure
Abnormal noise	Screws issue Fan blade or motor issue Compressor issue Components have collision	Screws Fan Compressor Other components (tubes, cables)	Check the screws Check the fan blade and motor Check the compressor Check other components

14.2. Error Code Instruction

Error code	Error name	Relevant parts information	Review and resolve
E04	Electric heater over heat Protection		<ol style="list-style-type: none"> 1. Check the Electrical heating Overheat protector open or not. 2. Check the Electrical heater.
E08	Communication failure between PCB and display	Communication error between PCB and DISPLAY	<ol style="list-style-type: none"> 1. Check cable connection of PCB and DISPLAY. 2. Check the software version of PCB and DISPLAY.
E11	HP Protection	HP switch is open	<ol style="list-style-type: none"> 1. Check whether showing the error after unit shutdown. 2. Measure the discharge pressure when unit is running. 3. Detect EEV step, suction pressure, inlet/outlet water discharge and suction temp. 4. Release all the gas of the system and refill refrigerant according to the nameplate.
E12	LP Protection	LP switch is open	<ol style="list-style-type: none"> 1. Check whether showing the error after unit shutdown. 2. Measure the suction pressure when unit is running. 3. Detect EEV step, discharge pressure, inlet/outlet water discharge and suction temp. 4. Release all the gas of the system and refill refrigerant according to the nameplate.
E19	Primary Anti-freezing Protection	Ambient temp. $\leq 0^{\circ}\text{C}$, $A04-2^{\circ}\text{C} \leq \text{water inlet} \leq A04^{\circ}\text{C}$	It is the protection in winter. Once the water temperature rises up to $A04+4^{\circ}\text{C}$ or the ambient temp is higher than 1, the error code disappears.
E29	Secondary Anti-freezing Protection	Ambient temp. $\leq 0^{\circ}\text{C}$, water inlet $\leq A04-2^{\circ}\text{C}$	It is the protection in winter. Once the water temperature up to $A04+11^{\circ}\text{C}$ or the ambient temp is higher than 1, the error code disappears.
E19	Primary Anti-freezing Protection	Ambient temp. $\leq 0^{\circ}\text{C}$, $2^{\circ}\text{C} \leq \text{water inlet} \leq 4^{\circ}\text{C}$	It is the protection in winter. Once the water temperature rises up to 8°C or the ambient temp is higher than 1°C , the error code disappears.
E29	Secondary Anti-freezing Protection	Ambient temp. $\leq 0^{\circ}\text{C}$, water inlet $\leq 2^{\circ}\text{C}$	It is the protection in winter. Once the water temperature up to 15°C or the ambient temp is higher than 1°C , the error code disappears.
E032	Flow Switch Protection	Flow switch is open	<ol style="list-style-type: none"> 1. Detect the connection of cables. 2. Detect the flow switch. 3. Detect the water valve is opened or opened fully. 4. Detect the water pump and the filter. 5. Maybe there is some air in the water route.
E051	Compressor Over current Shutdown Fault	Compressor Over current	<ol style="list-style-type: none"> 1. Check ambient temp. and inlet/outlet water temp.; 2. Turn on the unit. Record and analyze the changing process of high/low pressure, discharge/suction temp., EEV step, compressor frequency and running current. 3. If they are OK, replace a new compressor driver board.
E065	High water outlet temp. protection		Check if the water flow is too low and the outlet water whether too high
E081	Communication failure between PCB and fan drive board	Communication error between PCB and fan drive board	<ol style="list-style-type: none"> 1. Check the connection between PCB and fan board. All of 12V-12V, GND-GND, A-A, B-B should be closed; 2. If they are closed, turn on the power, then measure the voltage between 12V and GND on fan board, if higher than 15V or lower than 7V, replace a new fan board.
E103	Fan motor overload protection		<ol style="list-style-type: none"> 1. Check if the fan motor running well. 2. Detect the current of fan motor. 3. If the current is more than 1A, it means the motor have problem and need to replace a new one. 4. If the current is less than 1A, it means the motor control module have problem and need to replace a new one.

E171	Anti-freezing Protection	inlet water \leq A04°C and the antifreeze temp \leq A04-A05 °C	<ol style="list-style-type: none"> 1. Check the water flow. 2. Check the outlet water temp sensor. 3. Measure the ambient temp. 4. Detect the connection of cables. 5. Check the record of defrosting, whether the defrosting time is too long or too often.
F01	Compressor activation failure		<p>Restart the unit.</p> <ol style="list-style-type: none"> 1. Check the changing process of EEV step, high pressure, low pressure, inlet/outlet water temp. 2. Check the connection of U/V/W between compressor and compressor driver board. 3. Check the compressor resistance. 4. Check compressor driver board.
F03	PFC Fault		<p>Restart the unit.</p> <ol style="list-style-type: none"> 1. Check the power supply connection and voltage supply is stable or not. 2. Replace a new compressor driver board.
F05	DC Bus Over voltage		<ol style="list-style-type: none"> 1. Check the voltage between DCP-IN and DCN-IN, if lower than 300V, the unit will get this protection. 2. Check the input voltage of R/S/T on compressor driver board, if lower than 210V, the unit will get this protection. 3. If they are OK, please replace a new compressor driver board.
F06	DC Bus Under voltage		<ol style="list-style-type: none"> 1. Check the voltage between DCP-IN and DCN-IN, if lower than 300V, it will get this protection; 2. Check the input voltage of R/S/T on compressor driver board, if lower than 210V, it will get this protection; 3. If they are OK, please replace a new compressor driver board
F07	AC Input Under voltage		<ol style="list-style-type: none"> 1. Measure the input voltage of R/S/T of driver board, if lower than 300V, it will get this protection. 2. If it's OK, replace a new compressor driver board.
F08	AC Input Over current		<p>Only in single phase unit. Restart the unit. Check if there is electric leakage. If not, replace a new drive board.</p>
F09	Input voltage sampling fault		<ol style="list-style-type: none"> 1. Make sure power supply not lower than 300V or higher than 500V; 2. If it's OK, please replace a new compressor driver board.
F10	Communication Failure between DSP and PFC		<p>Only in single phase unit.</p> <ol style="list-style-type: none"> 1. Check the inverter board connection. 2. If no problem, replace a new compressor driver board.
F11	Communication Fault between DSP and Communication board		<ol style="list-style-type: none"> 1. Please check the inverter board connection. 2. If no problem, please replace a new compressor driver board
F12	Communication failure between PCB and driver board		<ol style="list-style-type: none"> 1. Check the connection between main control board and compressor driver board. All of 12V-12V, GND-GND, A-A, B-B should be closed. 2. If they are closed, turn on the power, then measure the voltage between 12V and GND on compressor driver board, if higher than 15V or lower than 7V, please replace a new one compressor driver board.

F13	IPM Overheat Stop		<ol style="list-style-type: none"> 1. Check the fans are running or not. 2. Check the installation distance and space. 3. Leave enough distance and space to make heat pump have a good transfer heating condition. 4. Clean the finned heat exchanger. 5. If they are OK, replace a new compressor driver board.
F15	Input voltage Lacking Phase		<ol style="list-style-type: none"> 1. Check the phase of power supply R/S/T to compressor driver board. 2. If it's OK, replace a new compressor driver board.
F16	Compressor weak magnetic protection alarm		<ol style="list-style-type: none"> 1. Check the refrigeration system. 2. If it's OK, replace a new compressor driver board.
F17	Temperature fault of drive board		<ol style="list-style-type: none"> 1. Check the connection of heat sink temp. sensor. 2. Check the resistance of heat sink temp. sensor. 3. If they are OK, please replace a new heat sink and heat sink temp. sensor.
F18	IPM Current Sampling Fault		<ol style="list-style-type: none"> 1. Check ambient temp. and inlet/outlet water temp. 2. Check high/low pressure and discharge temp. and suction temp. 3. Check EEV step. 4. Check the compressor frequency and current. 5. If they are OK, replace a new compressor driver board.
F20	IGBT Power Device Overheat Alarm		<ol style="list-style-type: none"> 1. Check the fans are running or not. 2. Check the installation distance and space. 3. If they are OK, please replace a new compressor driver board. 4. Leave enough distance and space to make heat pump have a good transfer heating condition. 5. Clean air to fin heat exchanger.
F22	AC input over current protection alarm		<p>Only in single phase unit. Restart the unit.</p> <ol style="list-style-type: none"> 1. Check if there is electric leakage. 2. If still have the failure, replace a new drive board.
F23	EEPROM Fault Alarm		<ol style="list-style-type: none"> 1. Check the connection; 2. Replace a new driver board;
F24	Destroyed EEPROM Activation Ban Alarm		
F25	LP 15V Under load Fault		<ol style="list-style-type: none"> 1. Check the power supply is stable or not, and restart unit. 2. If the problem still on, please replace a new drive board.
F26	IGBT Power Device Overheat Fault		<ol style="list-style-type: none"> 1. Check the fans are running or not ; 2. Check the installation distance and space; 3. Leave enough distance and space to make heat pump have a good transfer heating condition; 4. Clean the finned heat exchanger. 5. If they are OK, please replace a new driver board;
F031	DC Fan Motor 1 Failure		<ol style="list-style-type: none"> 1. Turn off the unit and check the connection. 2. Restart and check if the motor is running normal or the error happens again. 3. Replace a new fan motor.
F032	DC Fan Motor 2 Failure		

Pp1	Exhaust Pressure Sensor Fault		<ol style="list-style-type: none"> 1. Detect the exhaust pressure sensor connection 2. If the connection is OK, please replace a new one.
Pp2	Suction Pressure Sensor Fault		<ol style="list-style-type: none"> 1. Detect the suction pressure sensor connection 2. If the connection is OK, please replace a new one.
TP	Low Ambient Temp. Protection	Ambient temp \leq -30	<ol style="list-style-type: none"> 1 Check the ambient temp 2. When ambient temp \geq-28°C, the fault will disappear.
P01	Water Inlet Temp. Sensor Fault		<ol style="list-style-type: none"> 1. Detect the connection. 2. Measure the resistance of sensor, if lower than 100Ω or higher than 500kΩ, please replace a new one.
P02	Water Outlet Temp. Sensor Fault		
P04	Ambient Temp. Sensor Fault		
P17	Water Outlet Temp. Sensor Fault		
P032	Hot Water Tank Temp. Sensor Fault		
P42	Room Temp. Sensor Fault		
P101	EVI Inlet Temp. Sensor Fault		
P102	EVI Outlet Temp. Sensor Fault		
P153	Coil Temp. Sensor Fault		
P181	Exhaust Temp. Sensor Fault		
P182	Exhaust Over Temp.	(Exhaust temp.) \geq C05 default 110	<ol style="list-style-type: none"> 1. Measure the resistance of sensor, if lower than 100Ω or higher than 500kΩ, please replace a new one. 2. Check the unit find if it has refrigerant leakage.
P191	Antifreeze Temp. Sensor Fault		<ol style="list-style-type: none"> 1. Detect the connection 2. Measure the resistance of sensor, if lower than 100Ω or higher than 500kΩ, please replace a new one.

15. MODBUS RTU PROTOCOL

MODBUS RTU Communication Protocol

From: To:
Version V1.1 update: 2021/11/08

1. Transmission Format

Baud Rate	9600bps
Start bit	1
Byte width	8
Parity	N
Stop bits	1
Slave address	H10

2. Packet Format

Address	Function	Data	CRC checksum
16bits	16bits 03: Function of reading multi registers 16: Function of presenting multi registers	N*16bits	16bits

3. Data types

Data Types	Description
TEMP	Signed byte, 0.1 °C resolution, formula: T*10, the temperature range is -30~97 °C (when 25 °C is displayed, the data transmitted by the protocol is 250 according to the above formula; When the display is -25 °C, the data transmitted by the protocol is -250; when bit15 is 1, it represents a negative number, and when bit15 is 0, it represents an integer;), when this value is 32767, it indicates that the corresponding sensor is faulty.
DIGI1	Unsigned byte, unit 1, data transmitted is 123 when 123 is displayed.
DIGI2	Unsigned byte, unit 10, data transmitted is 123 when 1230 is displayed.
DIGI3	Unsigned byte, unit 100, data transmitted is 123 when 12300 is displayed.
DIGI4	Unsigned byte, unit 100, data transmitted is 123 when 12300 is displayed.
DIGI5	Unsigned byte, unit 0.1, data transmitted is 123 when 12.3 is displayed.
DIGI6	Unsigned byte, unit 0.001, data transmitted is 123 when 0.123 is displayed.
DIGI9	Unsigned byte, unit 0.01, data transmitted is 12 when 0.12 is displayed.

4.Mailing address

Address	Function	Number	Content	mode	Default	Description	Remark
1011	03/06		Power on/off	read/write		0-OFF/1-ON	DIGI1
1012	03/06		Mode	read/write		H05=1: 0-Hot water/1-Heating/2-Cooling/3-Hot water + heating/4-Hot water + Cooling H05=0: 0-Hot water/1-Heating/3-Hot water + heating	DIGI1
1045	03/06		Forced switching time for heating water	read/write	120	1~180min	DIGI1
1157	03/06	H32	Domestic hot water target temperature	read/write	55	R36-R37	TEMP1
1158	03/06	R01	Heating target temperature	read/write	45	R10~R11	TEMP1
1159	03/06	R02	Cooling target temperature	read/write	7	R08~R09	TEMP1
1160	03/06	R03	Heating start-up return difference	read/write	2	0~10°C	TEMP1
1161	03/06	R04	Heating constant temperature shutdown temperature difference	read/write	1	0~10°C	TEMP1
1173	03/06	R05	Use of electric heating	read/write	0	0-No electric heating/1-water circuit electric heating/2-water tank electric heating	DIGI1
1174	03/06	R35	Cooling start-up return difference	read/write	2	0.0~10.0°C	TEMP1
1175	03/06	R06	Cooling constant temperature shutdown temperature difference	read/write	1	0.0~10.0°C	TEMP1
1193	03/06	R07	Operating ambient temperature of main circulating pump	read/write	2	-10~20°C	TEMP1
1194	03/06	R40	Operating ambient temperature of air conditioning pump	read/write	2	-10~20°C	TEMP1
1195	03/06	R41	Hot water start-up return difference	read/write	5	0~10°C	TEMP1
1196	03/06	R16	Hot water constant temperature shutdown temperature difference	read/write	2	0~10°C	TEMP1
1197	03/06	R17	Operating mode of circulating water pump	read/write	2	0-normal/1-special/2-intermittent	TEMP1
1198	03/06	P01	Circulating water pump operation time interval	read/write	30	1~120min	DIGI1

1199	03/06	P02	Circulating water pump operation duration	read/write	3	1~30min	DIGI1
1201	03/06	P03	Operating mode of domestic hot water pump	read/write	2	0-normal/1-special/2-intermittent	DIGI1
1202	03/06	P05	Manually controlled water pump	read/write	0	0-off/1-on	DIGI1
2011	16		Power On/Off state	Write		0-power off/1-power on	DIGI1
2012	16		Operation mode	write		0-Cooling/1-heating/2-defrosting/3-high temperature disinfection/4 hot water	DIGI1
2013	16		Current temperature value (after limit)	write			DIGI1
1238	03/16	R62	Max water outlet temperature of heat pump	Read/write	62	45-95°C	TEMP1
2014	16		Current temperature value (after compensation, for heating mode only)	write			TEMP1
2019	16	O01~023		write		bit0: O01 System 1 compressor output (0-OFF/1-ON) bit1: Reserved bit2: O03 Fan high speed output (0-OFF/1-ON) bit3: O04 Fan low speed output (0-OFF/1-ON) bit4: O05 Main circulating water pump output (0-OFF/1-ON) bit5: O06 Domestic hot water pump output (0-OFF/1-ON) bit6: O07 Four-way valve 1 (0-OFF/1-ON) bit7: O08 Electric heating energy level one (0-OFF/1-ON) bit8: O09 Electric heating energy level two (0-OFF/1-ON) bit9: O10 Hot water 3-way valve (0-OFF/1-ON) bit10: O11 Alarm output (0-OFF/1-ON) bit11: O12 crankshaft heating tape (0-OFF/1-ON) bit12: O13 chassis heating tape (0-OFF/1-ON) bit13: O21 heating pump (0-OFF/1-ON) bit14: O22 hydraulic module water circuit electric heating (0-OFF/1-open) bit15: O23 hydraulic module water tank	DIGI1

						electric heating (0-OFF/1-ON)	
2034	16	S01~S10		write		bit0: S01 system 1 high voltage switch (0-ON/1-OFF) bit1: S02 system 1 low voltage switch (0-ON/1-OFF) bit2: S03 water flow switch (0-ON/1-OFF) bit3: S04 electric heating overload switch (0-ON/1-OFF) bit4: S05 emergency input (0-ON/1-OFF) bit5: S06 air conditioning mode switch (0-ON/1-OFF) bit6: S07 hot water mode switch (0-ON/1-OFF) bit7: Reserved bit8: Reserved bit9: S10 A/C switch (0°C-ON/1°C-OFF) bit10: Reserved bit11: Reserved bit12: Reserved bit13: Reserved bit14: Reserved bit15: Reserved	DIGI1
2045	16	T01	Water inlet temperature	write		Measured value	TEMP1
2046	16	T02	Water outlet temperature	write		Measured value	TEMP1
2047	16	T08	Water tank temperature	write		Measured value	TEMP1
2048	16	T04	Ambient temperature	write		Measured value	TEMP1
2072	16	T31	Compressor operating frequency	write		Measured value	DIGI1
2074	16	T27	DC fan 1 speed	write		Measured value	DIGI1
2075	16	T28	DC fan 2 speed	write		Measured value	DIGI1

2081	16			write	bit0: IPM over current failure bit1: Compressor drive failure bit2: Compressor over current bit3: Input voltage phase loss bit4: IPM current sampling failure bit5: Drive board device over temperature protection bit6: Pre-charge failure bit7: DC bus over voltage bit8: DC bus under voltage bit9: AC input under voltage bit10: AC input over current shutdown bit11: Input voltage sampling failure bit12: Communication failure between DSP and PFC bit13: Drive board temperature sensing failure bit14: Communication failure between DSP and communication board bit15: Communication failure with main control board	DIG11
2082	16			write	bit0: IPM module overheat shutdown bit1: Compressor phase loss bit2: Reserved bit3: Input current sampling failure bit4: Reserved bit5: Reserved bit6: EEPROM failure bit7: AC input over voltage protection bit8: Reserved bit9: Reserved bit10: Reserved bit11: Reserved bit12: Reserved bit13: Reserved bit14: Reserved	DIG11

						bit15: Compressor over speed protection	
2083	16			write		bit0: Compressor current frequency reduction alarm bit1: Compressor weak magnetic protection alarm bit2: Power unit overheat alarm bit3: Reserved bit4: AC input current frequency reduction alarm bit5: EEPROM fault alarm bit6: Reserved bit7: Burnt E2 disable start failure bit8: Reserved bit9: Reserved bit10: Reserved bit11: Reserved bit12: Reserved bit13: Reserved bit14: Reserved bit15: Reserved	DIGI1
2085	16			write		bit0: Reserved bit1: Reserved bit2: Heating return water temperature sensing failure (0-no/1-yes) bit3: Heating outlet water temperature sensing failure (0-no/1-yes) bit4: High voltage protection of system 1 (0-no/1-yes) bit5: Reserved bit6: Low voltage protection of system 1 (0-no/1-yes) bit7: Reserved bit8: Water flow switch protection (0-no/1-yes) bit9: Electric heating overload protection (0-no/1-yes) bit10: Primary I anti-freezing protection in winter (0-no/1-yes)	DIGI1

						bit11: Secondary anti-freezing protection in winter (0-no/1-yes) bit12: Anti-freezing protection of system 1 (0-no/1-yes) bit13: Reserved bit14: room temperature sensing failure (0-no/1-yes) bit15: Reserved	
2086	16			write		bit0: System 1 exhaust over-temperature protection (0-no/1-yes) bit1: Reserved bit2: Reserved bit3: Fan 1 overload speed limit (0-no/1-yes) bit4: Fan 2 overload speed limit (0-no/1-yes) bit5: Protection for excessive water temperature difference between inlet and outlet (0-no/1-yes) bit6: Protection against excessive outlet water temperature (0-no/1-yes) bit7: Water mixer outlet water temperature sensing failure (0-no/1-yes) bit8: Hot water return water temperature sensing failure (0-no/1-yes) bit9: Hot water outlet temperature sensing failure (0-no/1-yes) bit10: Reserved bit11: Reserved bit12: Reserved bit13: Reserved bit14: Reserved bit15: Reserved	DIG11

2087	16			write	<p>bit0: Reserved</p> <p>bit1: Reserved</p> <p>bit2: Reserved</p> <p>bit3: Reserved</p> <p>bit4: System 1 high-voltage protection for 3 times or more (0-no/1-yes)</p> <p>bit5: Reserved</p> <p>bit6: System 1 low-voltage protection for 3 times or more (0-no/1-yes)</p> <p>bit7: Reserved</p> <p>bit8: Water flow switch protection for 3 times or more (0-no/1-yes)</p> <p>bit9: Electric heating overheating protection for 3 times or more (0-no/1-yes)</p> <p>bit10: Reserved</p> <p>bit11: Reserved</p> <p>bit12: System 1 anti-freezing protection for 3 times or more (0-no/1-yes)</p> <p>bit13: Reserved</p> <p>bit14: Reserved</p> <p>bit15: Reserved</p>	DIG11
2088	16			write	<p>bit0: System 1 exhaust over-temperature protection for 3 times or more (0-no/1-yes)</p> <p>bit1: Reserved</p> <p>bit2: Excessive inlet and outlet water temperature difference failure 3 times or more (0-no/1-yes)</p> <p>bit3: Outlet water temperature too low protection for 3 times or more (0-no/1-yes)</p> <p>bit4: Outlet water temperature too high protection for 3 times or more (0-no/1-yes)</p> <p>bit5: Reserved</p> <p>bit6: Reserved</p>	DIG11

						bit7: Reserved bit8: Reserved bit9: Reserved bit10: Reserved bit11: Reserved bit12: Reserved bit13: Reserved bit14: Reserved bit15: Reserved	
2089	16			write		bit0: Inlet water temperature sensing failure (0-no/1-yes) bit1: Outgoing water temperature sensing failure (0-no/1-yes) bit2: System 1 coil temperature sensing failure (0-no/1-yes) bit3: Ambient temperature sensing failure (0-no/1-yes) bit4: System 1 return air temperature sensing failure (0-no/1-yes) bit5: System 1 anti-freezing 1 temperature sensing failure (0-no/1-yes) bit6: Outlet coil temperature sensing temperature failure (0-no/1-yes) bit7: Reserved bit8: Reserved bit9: System 1 EVI inlet temperature failure (0-no/1-yes) bit10: System1 EVI outlet temperature failure (0-no/1-yes) bit11: System1 exhaust temperature failure (0-no/1-yes) bit12: Reserved	DIG11

						bit13: System 1 pressure sensor failure (0-no/1-yes) bit14: Low ambient temperature protection (0-no/1-yes) bit15: Outlet water too low temperature protection (0-no/1-yes)	
2090	16			write		- bit0: Reserved bit1: Reserved bit2: Reserved bit3: Reserved bit4: Reserved bit5: Reserved bit6: Reserved bit7: Reserved bit8: Water tank temperature sensing failure (0-no/1-yes) bit9: Reserved bit10: Reserved bit11: Fan 1 failure (0-no/1-yes) bit12: Fan 2 failure (0-no/1-yes) bit13: Communication failure (E081 main board and DC fan)(0-no/1-yes) bit14: Communication failure with hydraulic module bit15: Communication failure (E082 main board and DC fan 2)(0-no/1-yes)	DIG11

MODBUS RTU PROTOCOL



COOPER&HUNTER CORPORATION, 2022

cooperandhunter.com

V202109HH01